

From: Baker, Kate H (Swift)
Sent: Sat Jul 10 15:08:37 2010
To: Tatro, Marjorie (Sandia National Laboratories); 'hickman@usgs.gov'
Cc: Tooms, Paul J; Wells, Kent; Dupree, James H
Subject: RE: today's presentation
Importance: Normal
Attachments: SIWOP Master Packv2a.ZIP

Margie, Here is the pack you requested except for Mike Mason's new slides on SIWHP. I have added in the slides on transient response during shut-in which I had inadvertently omitted from the initial handout pack, and which was distributed as a separate handout in the meeting. Thus, the slide numbers in the attached pack diverge from what you have in hardcopy beginning with slide 17. For example, the DOE/USGS presentation starts with slide 22 in the hardcopy handouts and the last slide is slide 81, whereas in the pack attached, the DOE/USGS presentation starts with slide 24 and the last slide is slide 83. Kate

From: Tatro, Marjorie [mailto:mltatro@sandia.gov]
Sent: Friday, July 09, 2010 7:08 PM
To: 'hickman@usgs.gov'; Baker, Kate H (Swift)
Subject: today's presentation

Hi Steve and Kate – could one of you please send me the electronic copy of the slides...I only have Ron's part and Tom Hunter would like to review the entire package.

Thanks
Margie

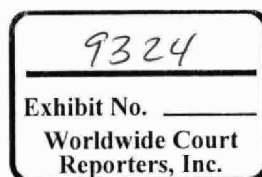

CONFIDENTIAL

BP-HZN-2179MDL06127378
BPD407-068731

TREX 009324.0001





Shut the Well in on Paper Benefits and Risks

Paul Tooms
9 July, 2010



Benefits of the Capping Stack

1. Assist in Well Kill & Post Kill Operations
 - Diagnosis of well integrity pre kill
 - Ability to backpressure well
 - Stabilisation of well pre and post cementing
2. Possibility of Shutting In Well
 - Full shut in for extended period
 - Temporary Shut in capability
 - Increased pressure / decreased flow.
3. Enable Full Collection Options
 - Multiple vessels, full collection without leakage
 - Ability to use export flow line
 - Possibility of Hurricane well storage option



Risks & Concerns for Shutting in

Well & formation Integrity issues

- Can we distinguish between depletion and leakage from the well?
- What is the consequence of leakage, and ultimately breaching to the seabed
- Can we adequately monitor to detect significant leakage from the well.

Operational Issues

- Gauge accuracy and dependability
- Communication and decision making
- Practicalities of opening well

Experimental Method

- Can we tell anything from transient behaviour?
- Do we need to bracket flow rates prior to starting the test?



Schedule and shut-in procedure for well integrity test

Trevor Hill
July 9, 2010



Schedule

- Earliest start of well integrity test is midday Tuesday, but subject to the operational complexities of 3 ram stack installation
- Contingency schedule is Saturday morning start

KNOWN CONDITIONS

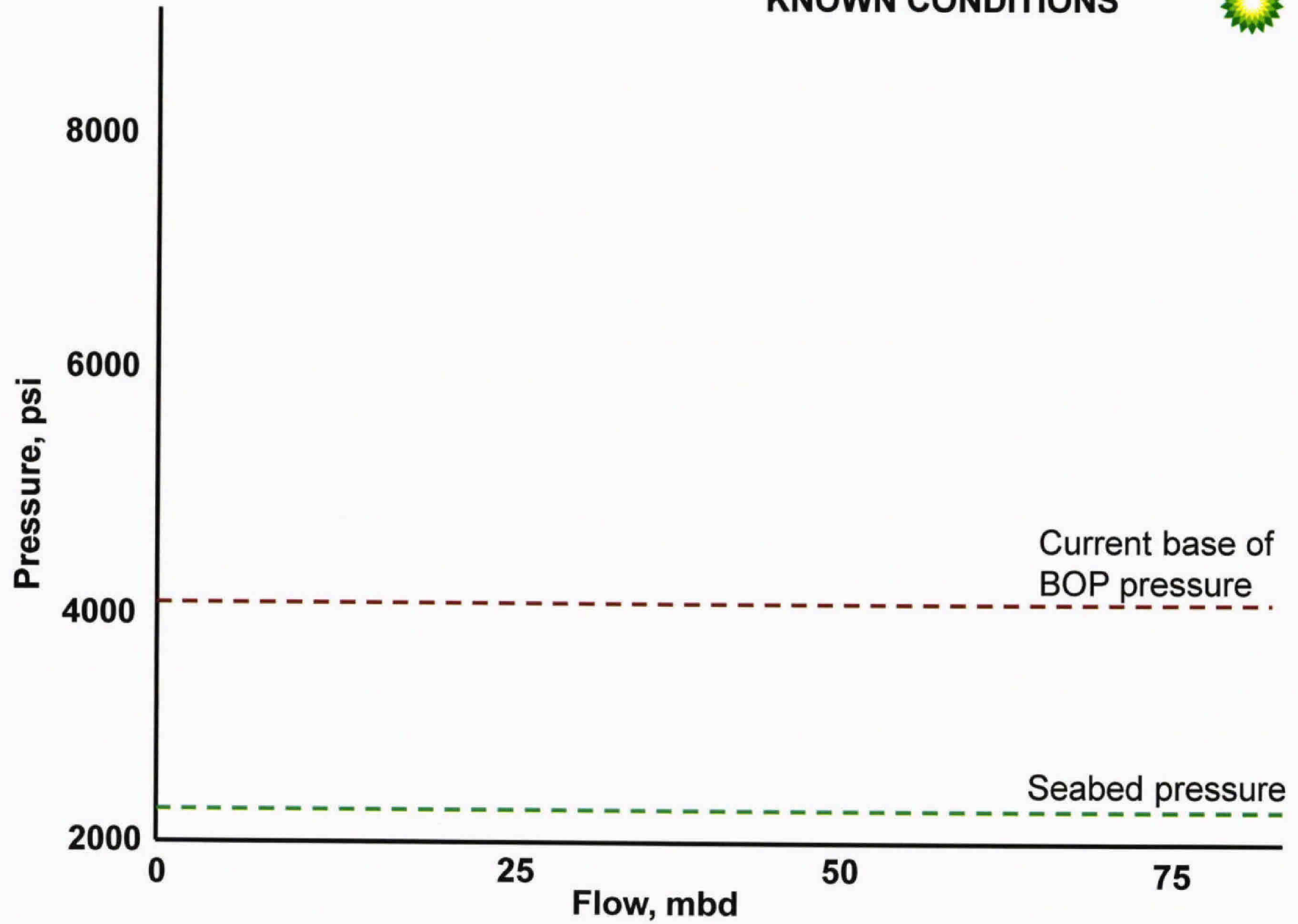



RANGE OF WELL CONDITIONS

Base of BOP pressure for different flowrates with ambient pressure at top of BOP

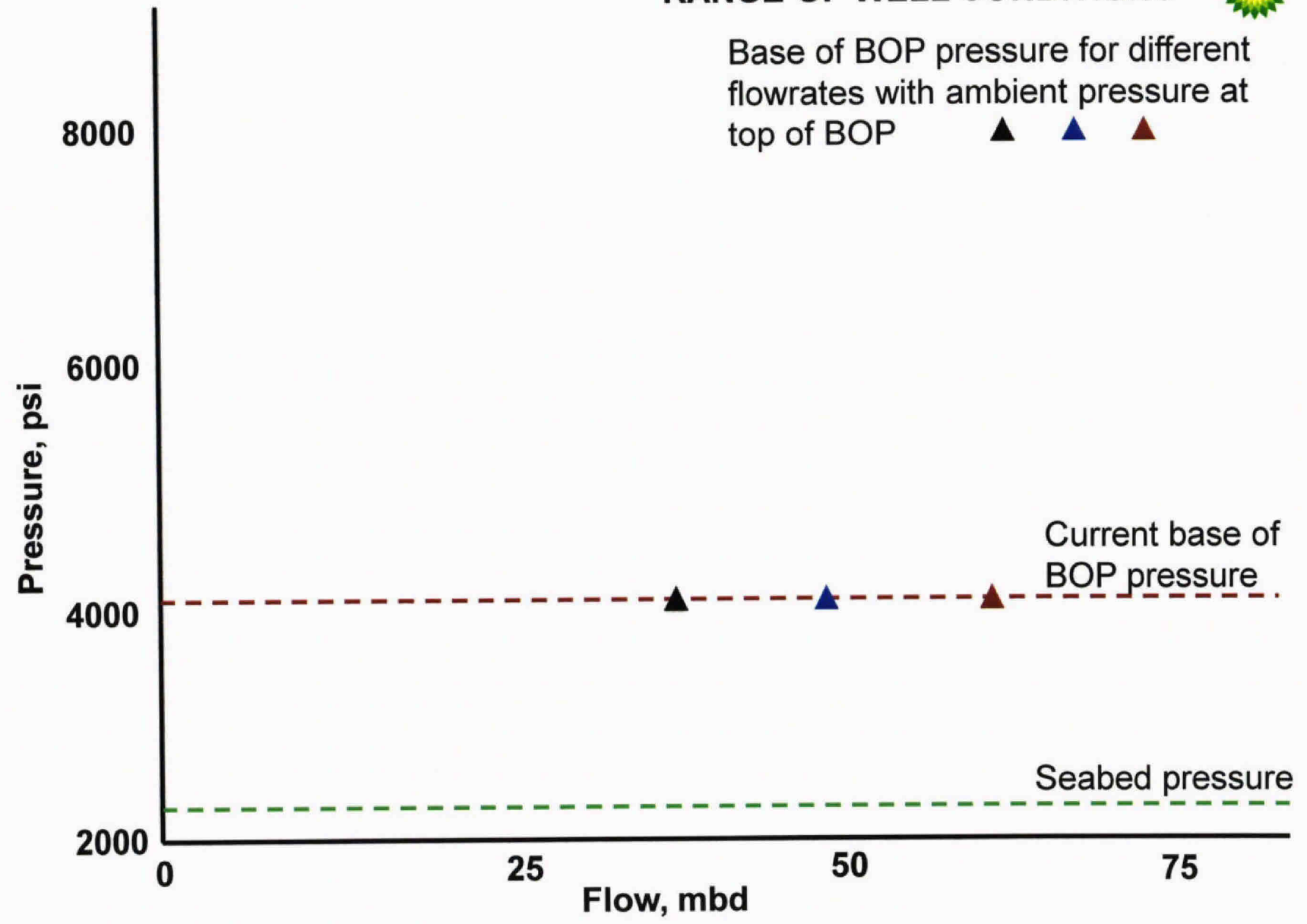

Shut-in pressure



WELL SHUT-IN

Base of BOP pressure for different flowrates with ambient pressure at top of BOP

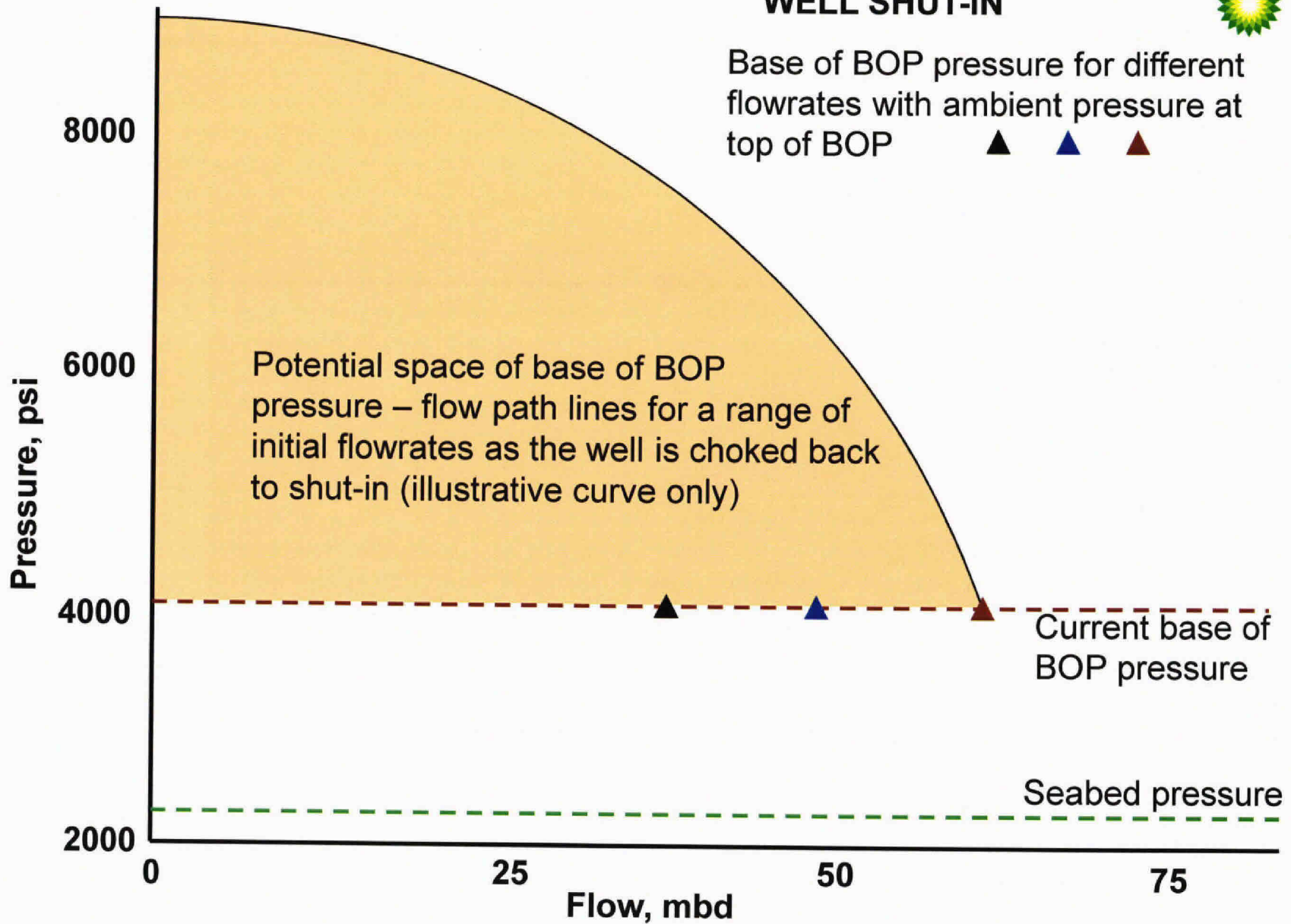



Shut-in procedure

- Enterprise will already be disconnected for 3 ram stack installation, but on stand-by with TopHat 7
- 3 ram stack will be installed with rams open and 2 x 3" outlets closed
- Helix Producer will be shut down, isolated, and on stand-by (if commissioned)
- Q4000 will be shut down, isolated, and on stand-by
- At this stage all flow will be out of the top of the 3 ram stack to sea via open rams

Shut-in procedure continued



- 3" vent line will be opened
- 3" choke will be opened fully
- Middle rams will be closed
- 3" vent line will be closed
- All flow now out of 3" choke to sea



Shut-in procedure continued

- Close 3" choke by specified increments,
- Increments will be planned in advance, but with operational response possible
- Monitor base of BOP and 3 ram stack pressures throughout
- Hold temporarily when just above bubble point to get single phase fluid in well
- Proceed to closure

Analysis during test



- Estimates of flowrate will be made as a function of choke valve position, C_v , and pressure drop
- Plot of pressure and estimated flowrate will be developed
- Pressure response will be evaluated before next choke increment



Pressure response

- Seconds – to see a response to a valve change at the BOP
- Minutes – to judge the magnitude of the response to that valve change
- Hours – to get to quasi steady state once the well is shut in
- Days – for the reservoir pressure to recover and gradually increase shut in pressure to final steady state



Reservoir Depletion

Bob Merrill
9 July, 2010



Characteristics of Reservoir Depletion / Build Up

Key Parameters: C_r , Aquifer, Q_o (including leakage, if any)

Assumptions: C_r : 12×10^{-6} psia⁻¹ [μ sips]
Aquifer: 3.8x reservoir oil volume
 Q_o : 35 mbd

Sensitivities: C_r : -200 psia, +100 psia [6, 18 μ sips]
Aquifer -800 psia, +100 psia [None, 14x]
 Q_o -350 psia [60 mbd]

Final M56E Pressure: 9,350 (lowest sensitivity) – 11,350 – 11,600 psia

S.I. Bottomhole (and hence tubing head) pressure will start at 1,500 – 3,000 psia below this (but 90% of this difference will disappear in 6 hours)

cases in red were used for SITHP calculations

Characteristics of Reservoir Depletion / Build Up



Base Case, with Build-Up Characteristics with and without leakage

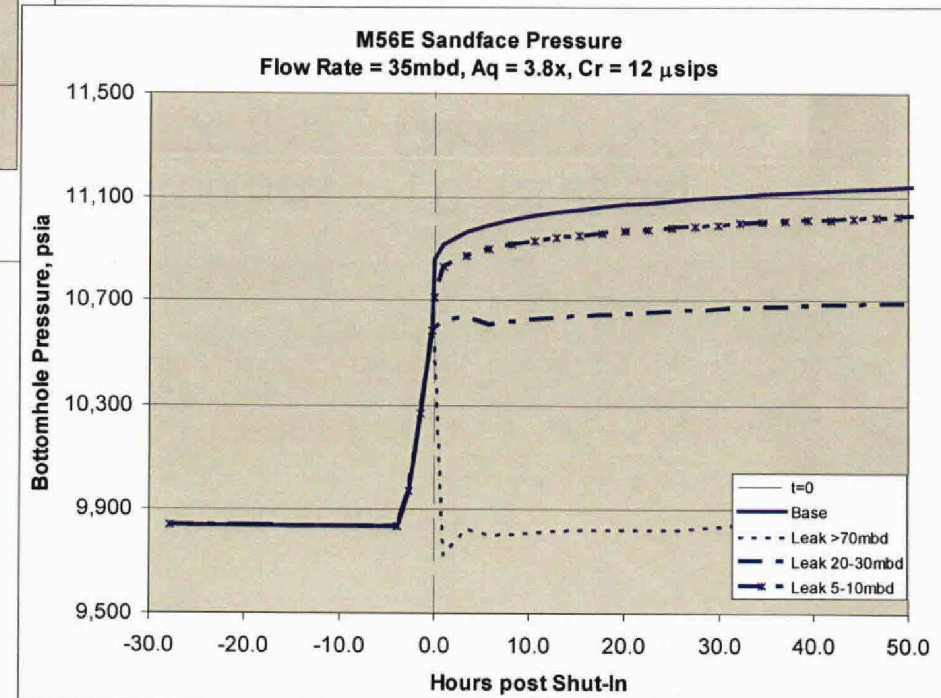
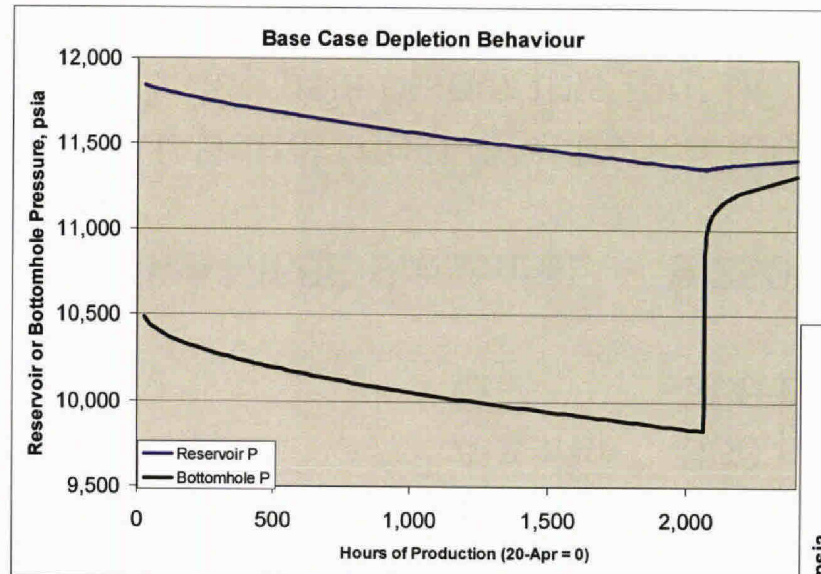



Transient Response During Shut In

Trevor Hill
July 9, 2010

Choke valve operation



- ROV will turn the choke valve actuator 18 times from open to closed position
- Response is not linear with number of turns
- Predictions give illustrative results of closing the choke on the pressure below the Horizon BOP stack
- Pressure below Horizon BOP stack will converge with pressure in 3 ram stack as choke reaches closed position

3 hour steady shut in of choke



Complete integrity

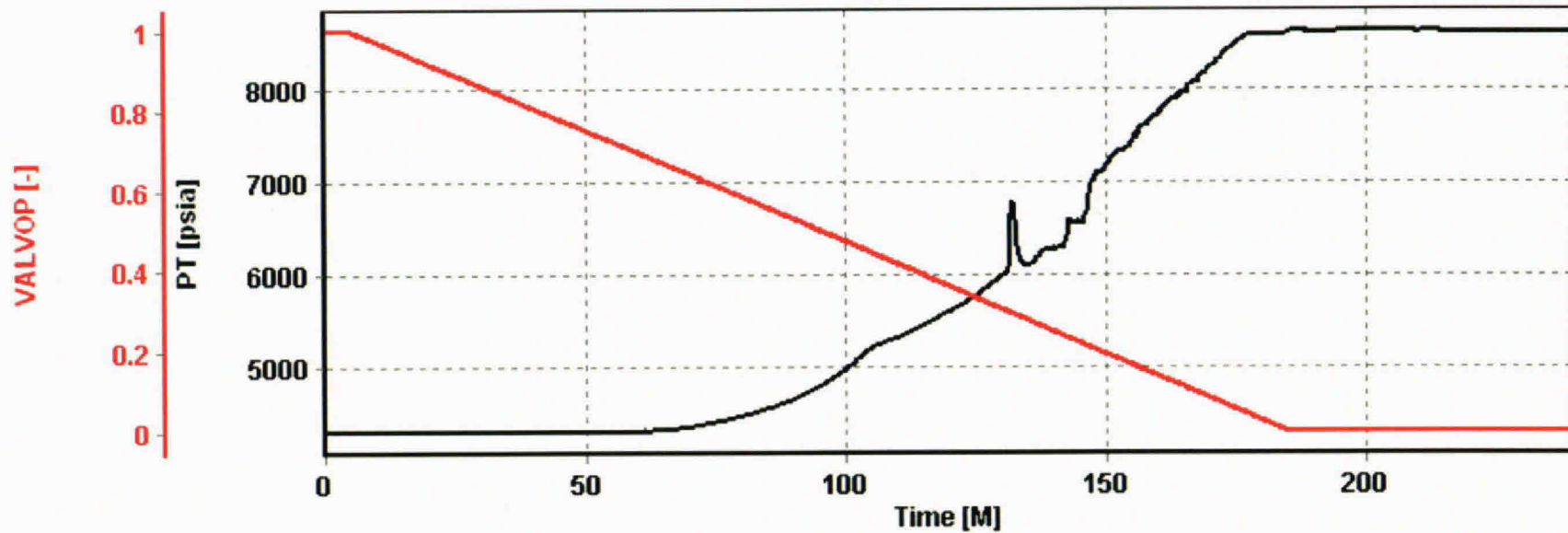

Rate of valve closure



Rupture discs used

6 x 0.125" holes
35 (lower) and 60 (higher) Mbd
5 and 60 minute closure
0.7 Mbd to M110

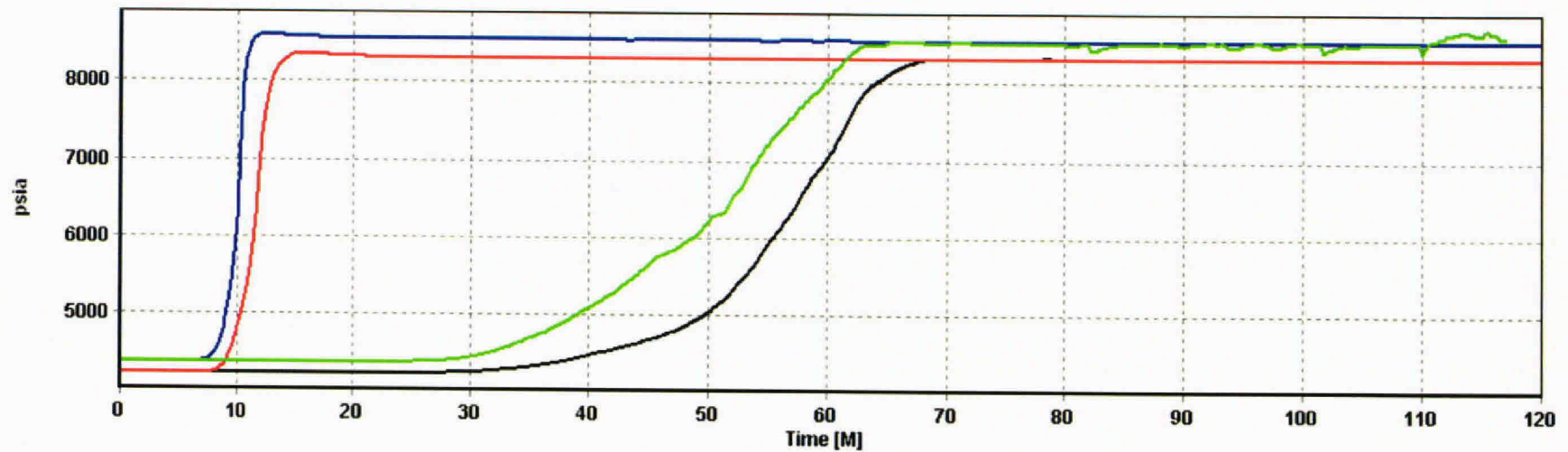

Larger opening to M110



6 x 0.4" holes
28 and 47 Mbd
60 minute closure
6.5 Mbd to M110

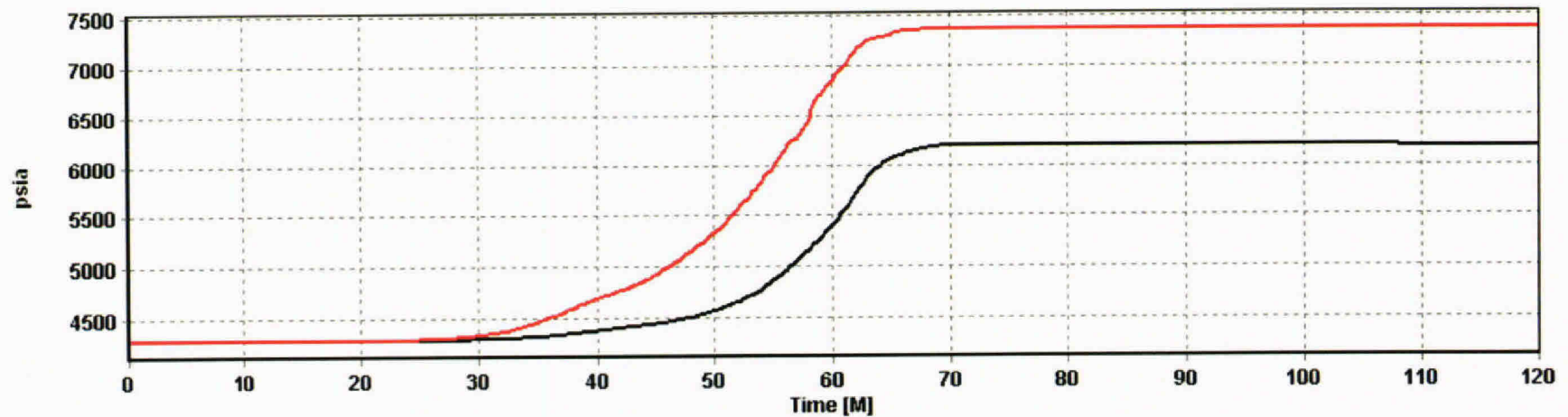

Stepped closure of choke

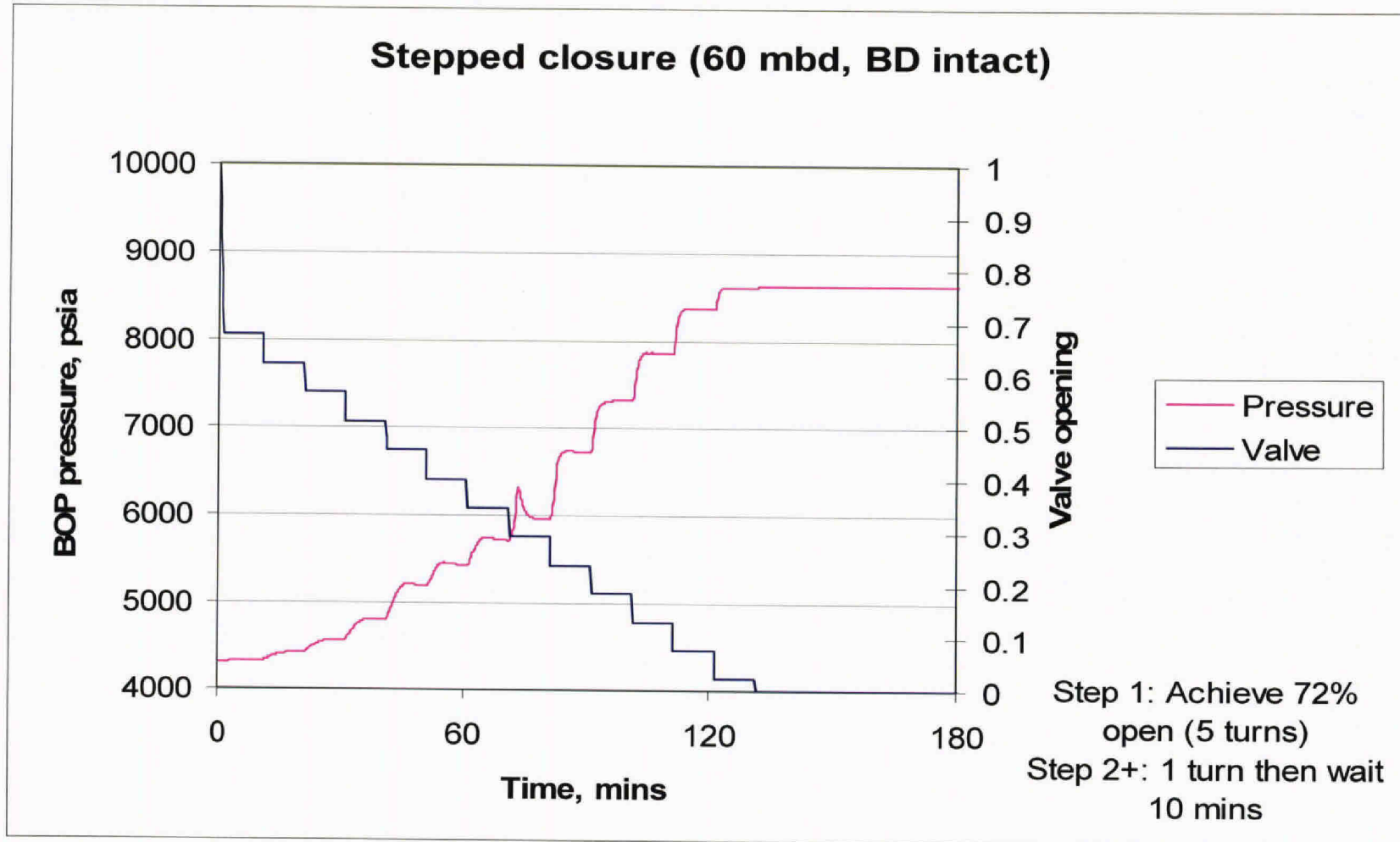

Cooling effect

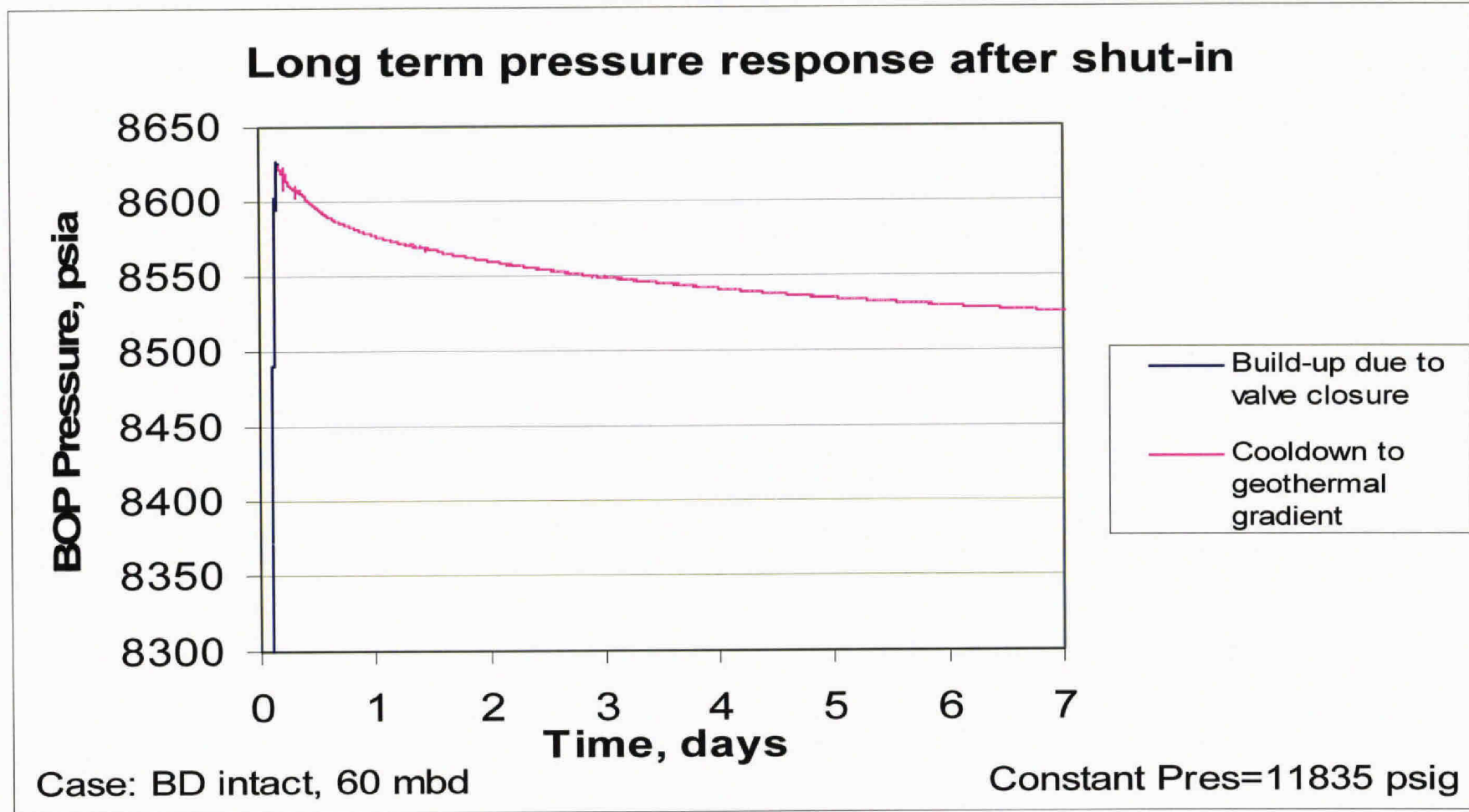

Well Integrity During Shut – In Operations: DOE/DOI Analyses

July 9, 2010



USGS
science for a changing world



 **Los Alamos**
NATIONAL LABORATORY

 **Sandia**
National
Laboratories

 **Lawrence Livermore**
National Laboratory

9/26/2012

24

Report Outline

- Issues to be Addressed
- Background
- Geologic Conditions
- Wellbore Flow Conditions
- Conclusions and Recommendations

Issues to be Addressed

- Are geologic conditions conducive to an uncontrolled broach to the sea floor during shut in, assuming a lack of well integrity?
- Can well integrity be assessed by pressure measurements during a shut in?



Background

9/26/2012

27

TREX 009324.0029

Reference Geometry - Below Mudline

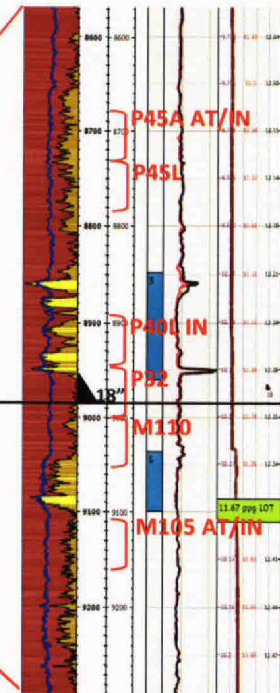
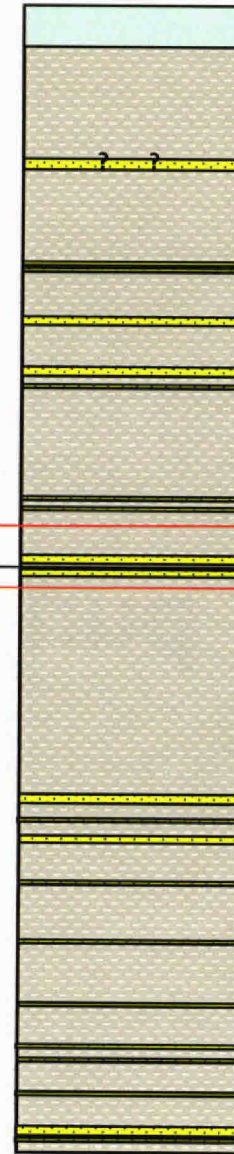
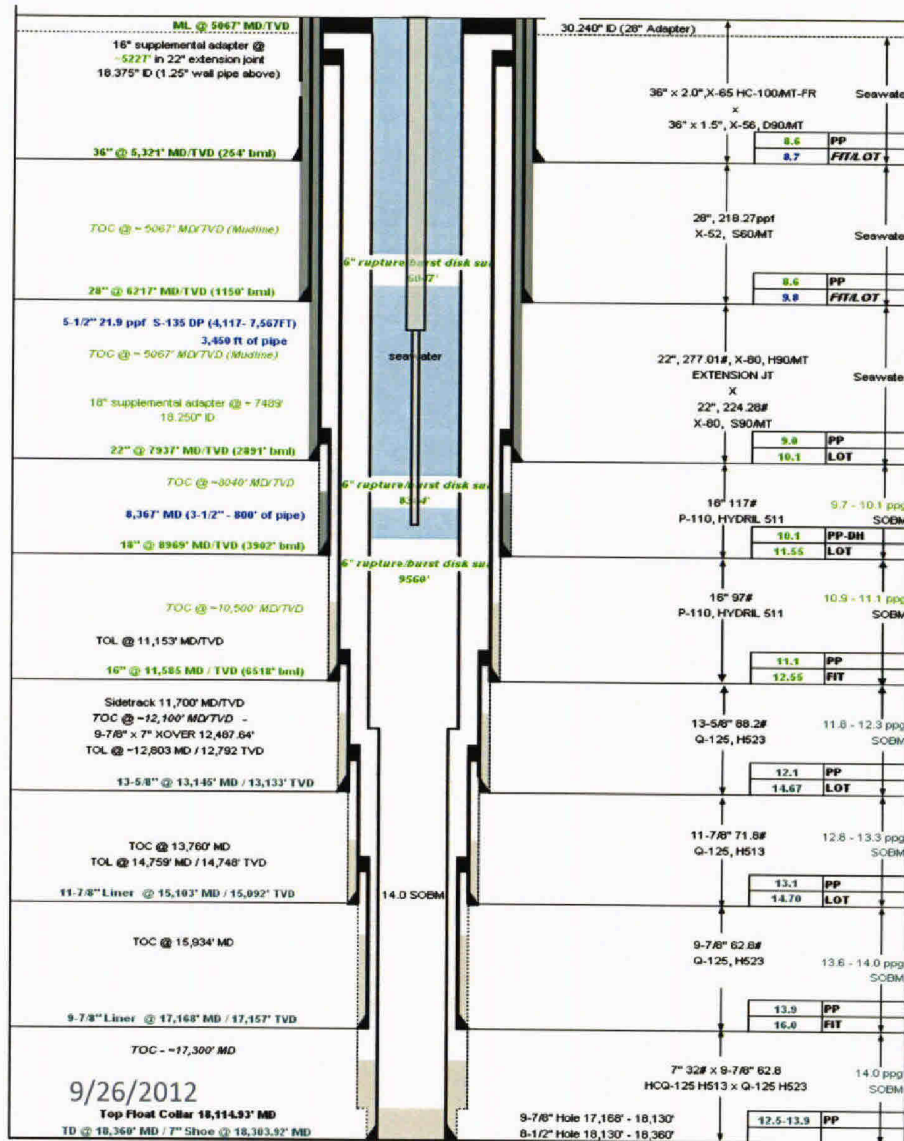

Legend for Stratigraphic Column:

Grey – predominately shale or mudstone.

Yellow – mixed siltstone, mudstone and sandstone.

Advantages of Installing Well Cap

- Well cap will allow full capture of hydrocarbons.
- Well cap has capability of shutting in well at seafloor.
- Well cap provides back pressure, which is beneficial to kill and cement operation.
- Well cap provides new capabilities for quick disconnect as hurricane approaches.

Possible Shut In Durations

- Shut in test
 - Minimum duration
 - Necessary to manage risk appropriately
- Duration of Shut in Decisions
 - Short duration (<1 day)
 - Short shut in for operational reasons
 - Mid-duration (< 10 days)
 - Hurricane
 - Well kill control/back-pressure enhancement
 - Long-duration (<100 days)
 - Minimize flow to gulf
 - Minimize hazards to personnel
 - Focus resources on well kill

Geologic Conditions

9/26/2012

31

TREX 009324.0033

Data Reviewed

The following were examined from the Macondo #1 and other wells in the vicinity, including relief wells:

- Logging-while-drilling data (primarily gamma ray and resistivity), wireline logs, and mud logs.
- Geomechanical models and borehole measurements pertaining to in-situ pore pressure, overburden stress (lithostat) and fracturing pressure.
- 3D-seismic, high-resolution 2D-seismic, and side-scan sonar collected pre-drill and post-incident.

Consultation with BP

Detailed in-house discussions between BP and government scientists and engineers on topics that included:

- Lithologic and structural interpretations.
- Seafloor morphology.
- Drilling history and borehole completion.
- Stress and fluid pressure conditions.
- Geomechanical and fracture propagation modeling.
- Reservoir modeling and borehole fluid flow.
- Kill and cementing procedures.
- Microseismic monitoring and multichannel seismic.

Geologic Conditions

- Data indicate geological formations consist of fine-grained, low-permeability sediments such as shale, mudstones and siltstones, and few permeable sands at or above the 18 inch casing shoe (~4000 ft below seafloor).
- Data indicate extensional stress environment, which is conducive to vertical hydraulic fracture growth.
- Data indicate existence of numerous faults that are potential paths for hydrocarbon flow to sea floor.
- Significant oil and gas flowing from main reservoir 13,000 feet below seafloor to well-head.

9/26/2012

34

ROCK FAILURE MODES

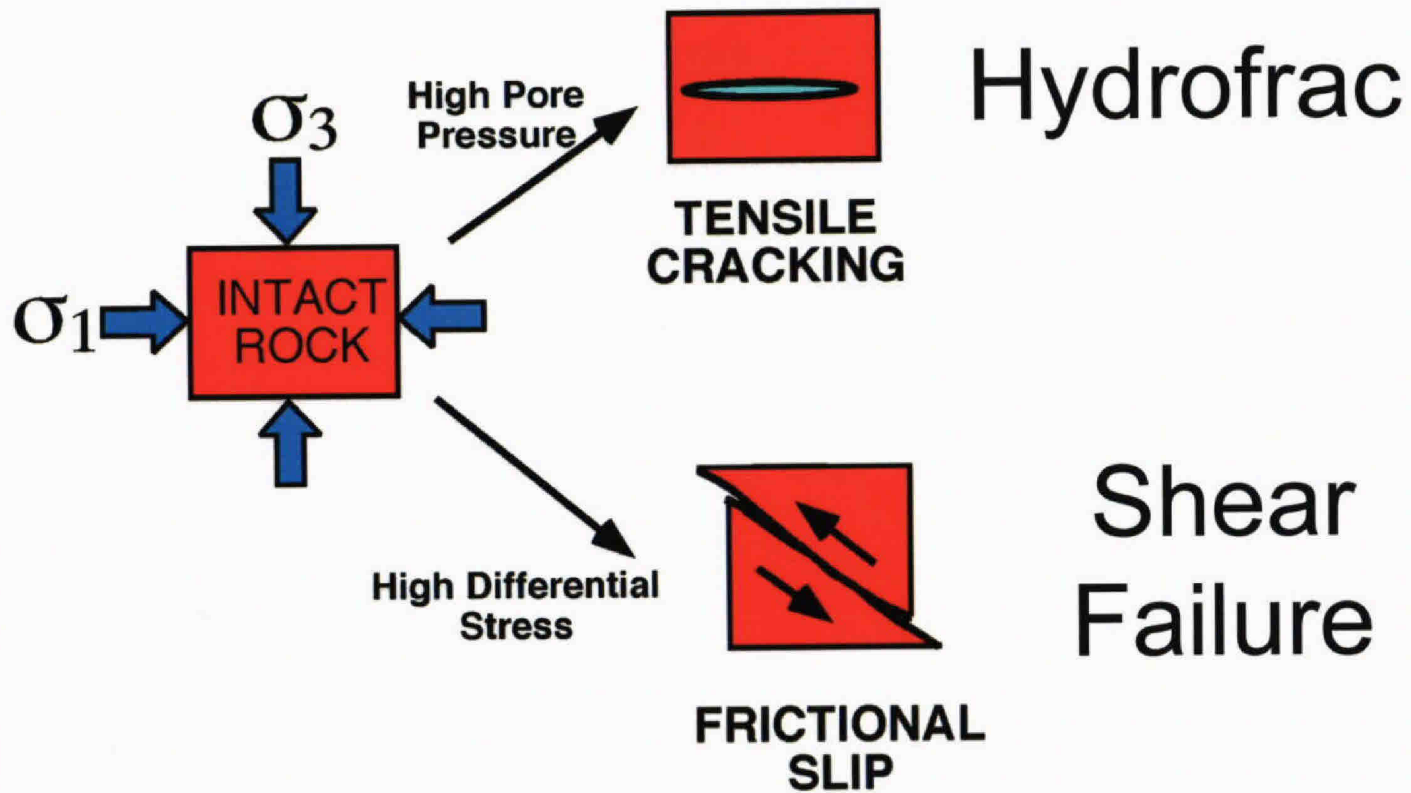

Macondo Well 1: WHP for Frac at 18" Shoe

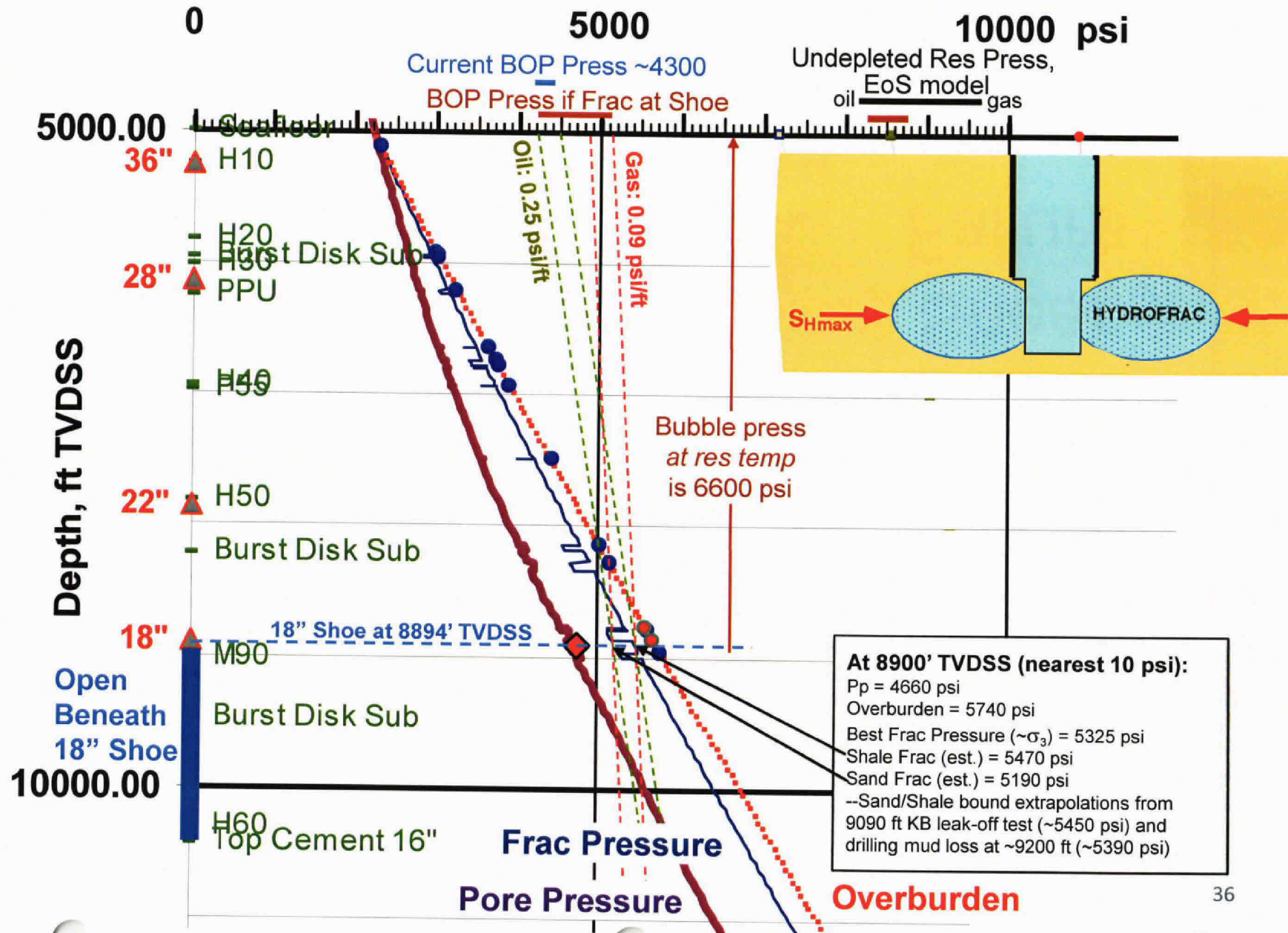

3D Seismic Line 17282 Through Well Location MC 252 #1

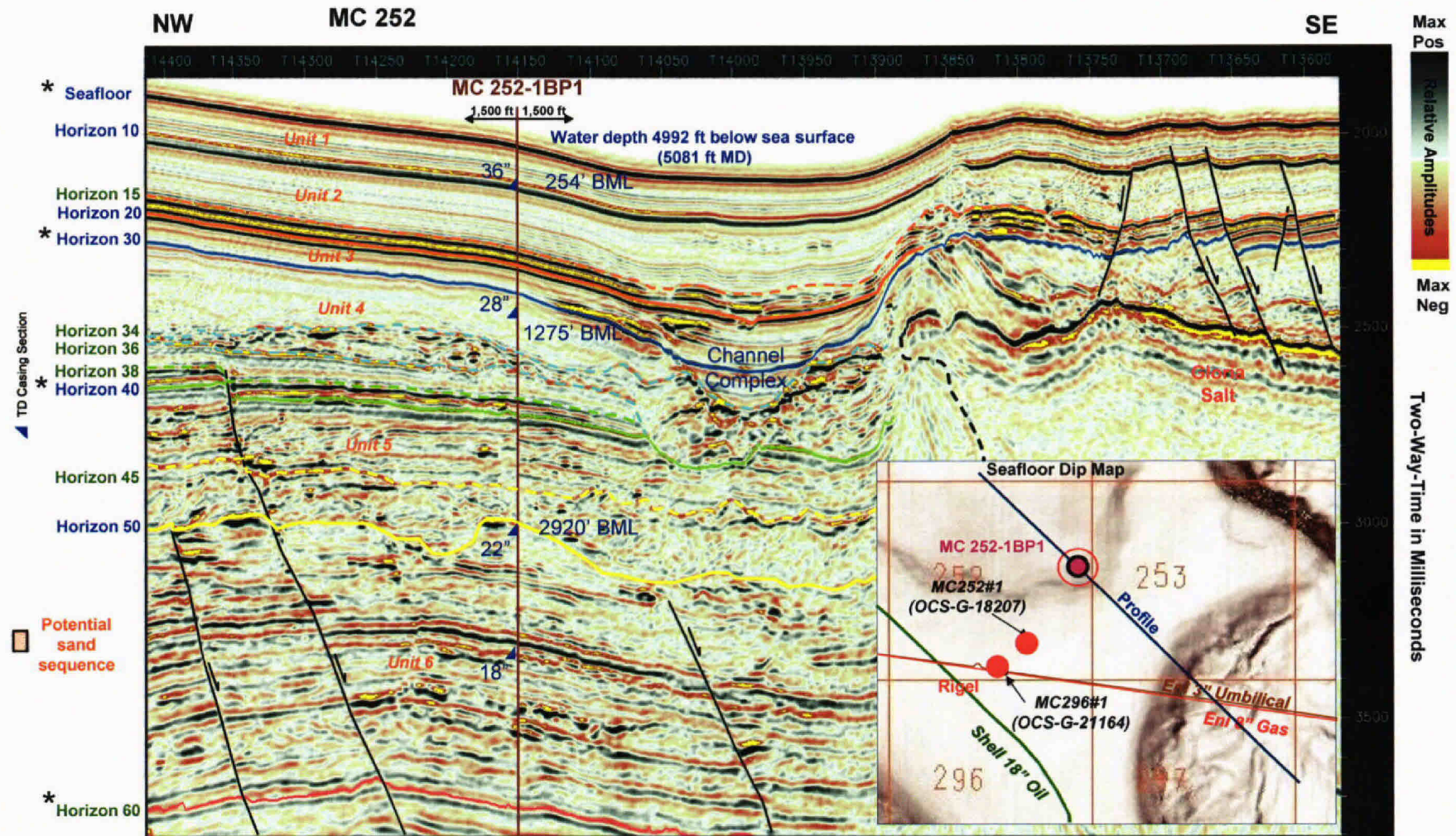

Horizon/Unit nomenclature after Fugro, 2003
 Green horizons – additional horizons correlated/mapped across area by BP, 2008/2009
 * Horizons mapped by BP across area for interval amplitude extraction purposes

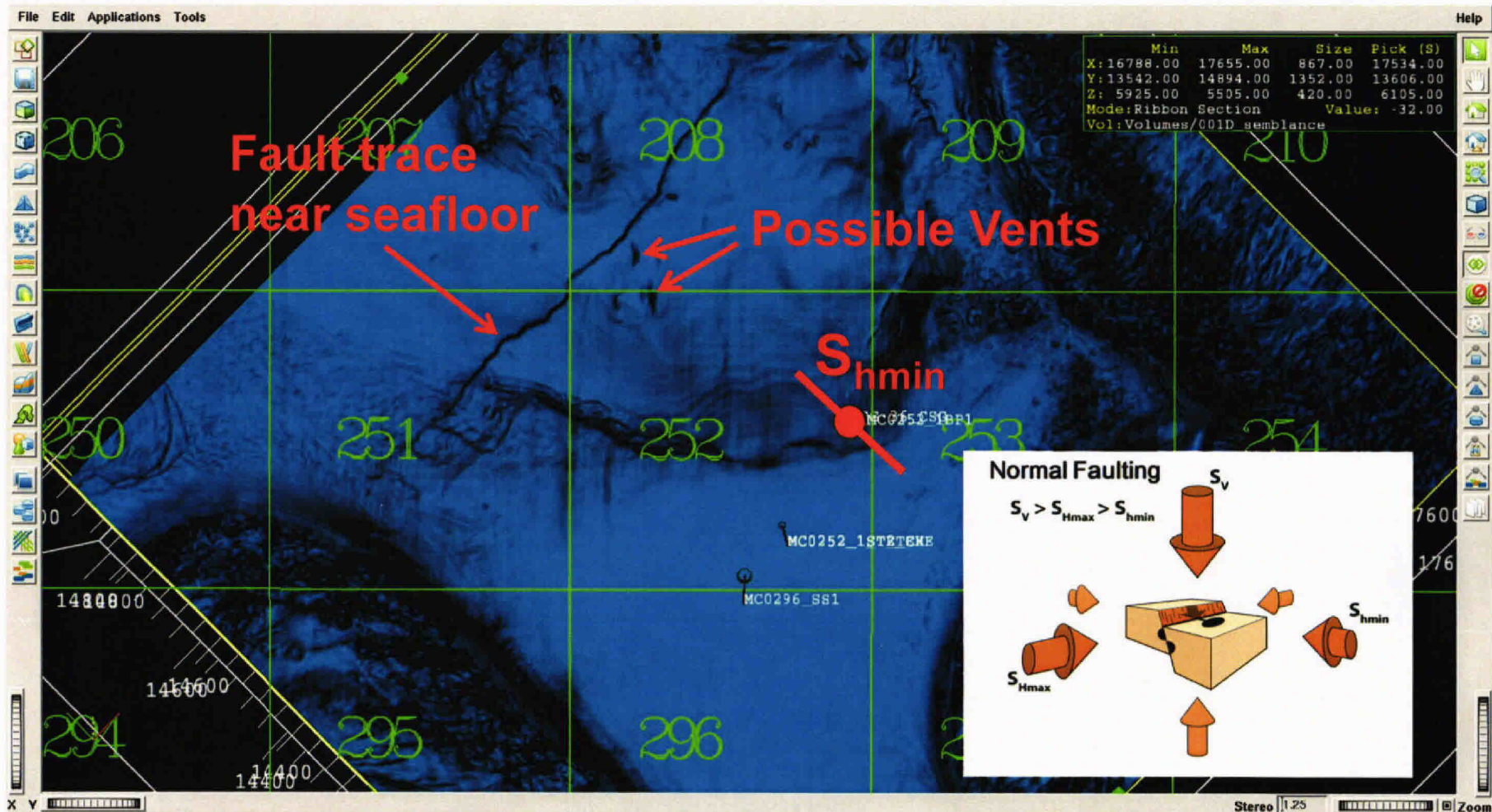

5505 feet below sea level: just below seafloor. With depth, this fault intersects the M110 horizon, and could be a conduit for hydrocarbon flow. Also visible are possible degassing or dewatering vents. These are potential sites for monitoring.

Implications of Geologic Conditions

- In the event of a casing leak, geologic formations and in-situ stress field are conducive to hydraulic fracture propagation from the 18" casing shoe to the seafloor.
- Pre-existing faults can also serve as conduits for hydrocarbon flow to seafloor.
- Limited thickness and areal extent of sand layers at and above the 18" shoe suggest that vertical fracture growth will not be significantly inhibited and that storage for hydrocarbons from a casing leak will be limited.

Possible Adverse Effects of Well Shut-In

In the event of a casing leak, geologic conditions are conducive to a broach of the seafloor by hydrocarbons during shut in, which would have serious consequences:

- There would be an uncontrolled release of hydrocarbons into the sea.
- This could result in an inability to control wellhead pressure, which could seriously jeopardize the bottom-kill and cementing operations.

Wellbore Flow Conditions

9/26/2012

41

TREX 009324.0043

Flow in Well Issues

- Principal Questions to be Addressed
 - A: Can well integrity be determined during short-duration shut-in?
 - B: Can well integrity be determined during longer shut-in?
 - C: Can well integrity be determined by a gradual shut-in?
 - D: Can the flow rate through the disks be bounded?
- Following analysis assumes that all leakage to the formation is through rupture disks.
- Other fluid-flow pathways out of well are also possible. In fact, one reason for doing the shut-in test is to determine if there is significant unknown damage to the wellbore.

Flow in Well Issues

Shut – In Pressure (SIWHP)

- Principal Uncertainties (1 observation dependent on 3 processes)
 - Extent of gas volumes after shut-in
 - Reservoir depletion
 - Leakage and flow pathways
- Government Assessment
 - SIWHP range: 8250 – 8750 psi (No depletion – No leakage)
 - No independent means of verifying reservoir depletion
 - BP estimates an uncertainty interval of 800 psi
 - Note – the pore pressure reduction associated with reservoir depletions depends on the flow rate, reservoir properties, and the of the reservoir volume.
 - Combined intervals span 1300 psi range

Flow in Well Issues

Leakage Through Burst Disks

- Principal Uncertainties
 - Number of disks open
 - Diameter of disk opening
 - Flow rate through disks
- Government Assessment
 - BP asserts that a maximum of 6 disks could have burst
 - Government has not independently analyzed accident scenario. For the purpose of our analysis, we assume that 6 burst disks have burst.
 - Flow = 550 bopd/disk into formation for 1/8" diameter disks
 - Disk diameter can increase through erosion. Recommend BP testing or analysis.
 - Limited data from other application suggests 6 hours of mud flow would result in < 20% increase flow rate.



Flow in Well Issues

Measuring Leakage at Shut In

- Principal Uncertainties
 - Sensitivity of shut-in pressure to leakage compared to shut-in pressure uncertainty
- Government Assessment
 - Simplified to Complex models – Assumptions in next slide, details in Appendix A and B
 - For every 1% of the flow from well head, shut in pressure will decrease by approximately 50 psi. Thus, for a 1300 psi uncertainty interval, this sensitivity corresponds to a flow of the scale of 25% of the flow from well head (assumes current leakage is small compared to well-head flow).

Flow in Well Issues

Basic Modeling Assumptions

- Modeling requires assumptions of the current well condition.
 - There is a significant resistance to flow in the well as illustrated by the 4300 psi BOP pressure measurement. This can be distributed to a deep and shallow choke. However, from steady flow observations one cannot determine the distribution of these resistances.
 - All wells have some resistance to fluid entering (well drawdown and skin resistance). We cannot measure this, but we can determine this as a function of the total flow rate if we assume other blockages (shallow choke) are small. The total flow rate must include the cross-flow (we have no way to measure cross-flow).
 - Any resistance assigned to a top choke makes the model predictions of well head pressure less sensitive to cross flow.
 - Simple scaling analysis shows that our inability in determining the current condition results in an inability in predict a shut in pressure. Our major unknowns are:
 - distributing resistance between a deep and shallow choke
 - inability in measuring the current cross flow
 - depletion of reservoir
 - elevation head

9/26/2012

46

Flow in Well Issues

Value of Discrete Steps During Shut-In

- Principal Uncertainties
 - Flow Measurement during shut-in
 - Limited number of measurements during shut-in
 - Transient conditions during shut-in
- BP Technical Staff Estimates of Capability
 - 3 perhaps 4 discrete measurements
- Government Assessment
 - Very difficult to make quantitative determination from 3-4 measurements.
 - Recommend single step shut-in.

Flow in Well Issues

Flow Rate Bounds - 1

- Government Assessment
 - There is no pressure for which it can be conclusively asserted that the well has zero flow out the burst disks.
 - However, flow rate can be bounded (next slide)
 - Bound informed by well performance
 - Theoretical upper bound for given flow area
 - Leakage flow into geologic media must be considered possible for all scenarios.

Flow in Well Issues

Flow Rate Bounds - 2

- Government Assessment

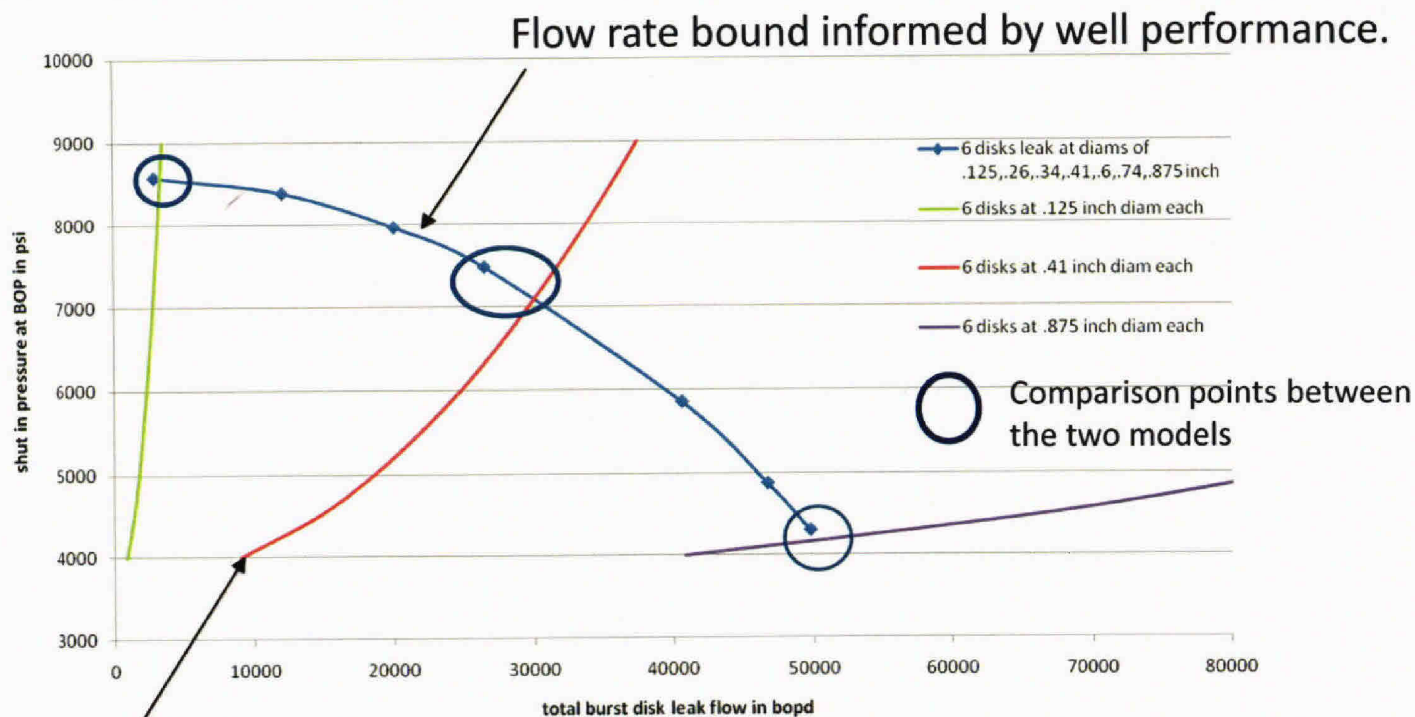

Flow rate theoretical bound for given flow area.

Multi-Step Shut-in (Quasi-steady Flow) Pore Pressure vs. Fracture Pressure

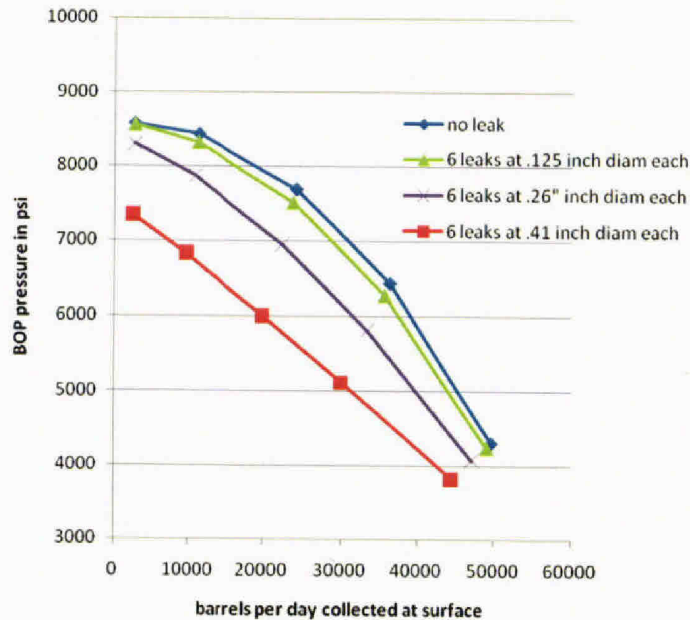

Assumes leaking into sand
- Currently above sand pore pressure

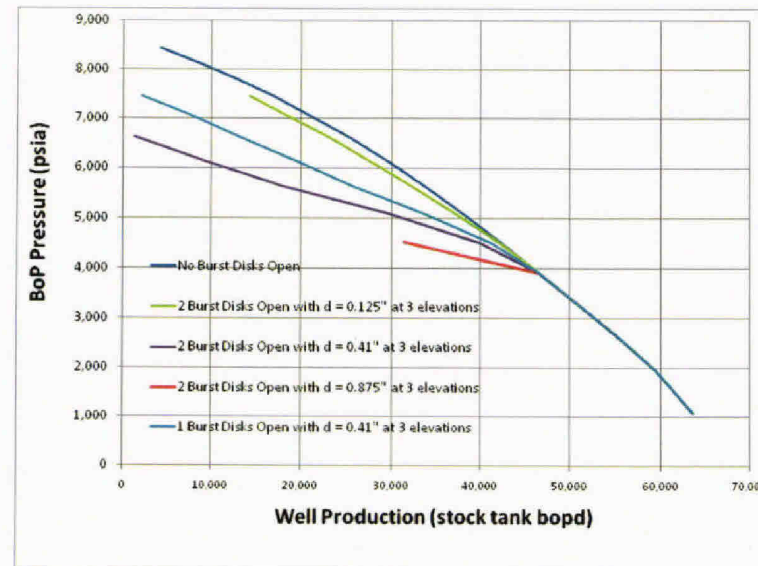

Assumes no leak until rock fracture
- Currently at or above rock fracture

Flow Sensitivity To Changes in Sink Pressure

- Scenario
 - Assume leakage from well, if it occurs, is limited to the burst disks (ignores possibly more extreme damage to the wellbore)
 - Model back pressure outside the burst disks as:
 - Pore pressure (conservatively no skin)
 - Fracture pressure
 - Hydrocarbon column to seabed
- Consequences For
 - Leakage flow rate
 - Kill difficulty
 - Broach capping

Decision Context/Recommendations

Response Determination

- Shut in pressure can be used to discriminate three categories
 - Pressure > 8000 psi
 - Well may have integrity but this cannot be assured due to uncertainties. Leak rates from worst case scenarios are bounded. Broach is possible but there is a low risk of to the well killing and cementing operation.
 - 8000 psi > Pressure > 6000 psi
 - Well does not have integrity. Discharge into formation is no worse than current discharge rate from well head. However, there is a moderate risk to the well killing and cement operation.
 - Pressure < 6000 psi
 - More is wrong in the well than just blown burst disks. Discharge into formation is greater than current discharge from well head, and broach to seafloor is likely for . There is a high risk to the well killing and cementing operation.

Conclusions and Recommendations

Risk Management Recommendation

- A successful well kill and cementing operation is the highest priority and should not be put at risk.
- The risk posed by a short-term shut-in test is acceptable if the test is required for operational reasons. However, to avoid possible broach to the surface, the shut-in period should not exceed 1 day. We see little value to a step-rate test.
- Intermediate and long-term shut-in could lead to a broach to the sea floor and could jeopardize well kill and cementing operations. Therefore:
 - These operations should only be undertaken after results of short term shut-in test are analyzed by BP and reviewed by the government.
 - Long-duration shut in should not be carried out unless BP can demonstrate the capability to continuously monitor fracture propagation to the sea floor (e.g., AUVs, seismic).

Risk Management Recommendation

Recommended Shut-In Protocol

| | Short Duration (<1 day) | Mid-Duration (< 10 days) | Long Duration (<100 days) |
|-------------------------|----------------------------|-----------------------------|------------------------------|
| P > 8000 psi | Green | Green | Yellow |
| 8000 psi < P < 6000 psi | Yellow | Yellow | Red |
| P < 6000 psi | Yellow | Red | Red |

- Green: Risk is low.
- Yellow: Risk is moderate to high.
- Red: Risk is unacceptable.

If wellhead pressure during test stabilizes at < 6000 psi then test should be immediately terminated.

Government Review Team

- Project POC
 - Sheldon Tieszen - DOE Natl. Labs
- Flow in Well
 - Curtt Ammerman – DOE Natl. Labs
 - Ron Dykhuizen – DOE Natl. Labs
 - Mark Havstad – DOE Natl. Labs
 - Charlie Morrow – DOE Natl. Labs
 - Marty Pilch – DOE Natl. Labs
- Flow in Geologic Media
 - Steve Hickman – USGS
 - Paul Hsieh – USGS
 - Walter Mooney – USGS
 - Phil Nelson – USGS
 - Cathy Enomoto – USGS



Communications and ROV Plan

Bill Grames
9 July, 2010

Communications



Key Roles

- Well Shut-in Test SPA  ROV Command
 - Stacks (Horizon and 3-Ram) SPA
 - Seabed SPA
 - Data SPA
 - Official Logger

Test Duration

Success Case

- Valve movements and initial pressure build-up ~6-12 hours
- Pressure monitoring 24 hours plus

Compromised Integrity Case

- Valve movement and initial pressure build-up 0-6 hours
- Containment vessels on stand-by to resume operation



ROV Plan

ROV Activities within Procedure

- Base of BOP Pressure Monitoring
- 3-Ram Stack Pressure Monitoring
- Choke Manipulation (open)
- Open choke isolation valves
- Open 3" vent valves
- Close middle rams
- Close 3" vent valves
- Manipulate choke

Indicative Timing

Continuous

Continuous

10 minutes

10 minutes

10 minutes

10 minutes

10 minutes

Duration of test

ROV Placement

- ROV1 Valve Manipulation
- ROV2 Base of BOP pressure
- ROV3 3-Ram Stack pressures
- ROV4 "Metal" leak surveillance
- ROV5 Seabed leak surveillance
- Redundancy provision being developed

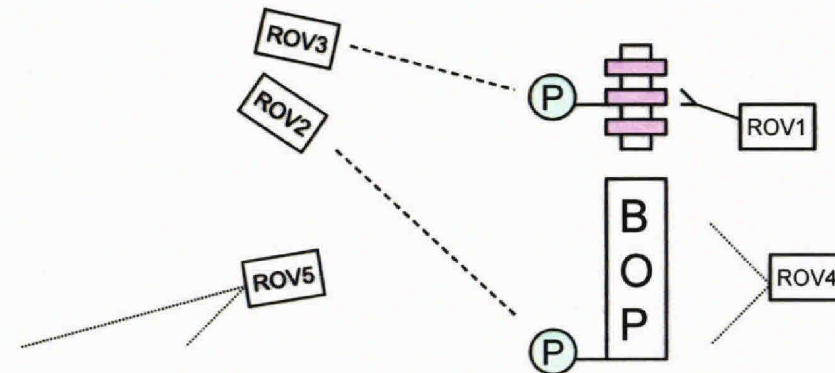



Macondo Overburden Seismic Evaluation Survey

Andy Hill, Marine Geohazards SETA, 9th July 2010



Subsurface: Defining absence of break out from the well

- Seismic methods for identification of activity, or change, in the subsurface are:
 - *Active Seismic*
 - Acquisition of targeted 2D Seismic Lines over well (Standard, MR or HR)
 - Proven published post-blowout methodology (Norway, Canada and Vietnam):
 - Degree of Ambiguity: low, degree of confidence of identifying charged layer is high.
 - Lower confidence if charge is restricted to a single fracture or fracture zone
 - Acquisition of a 3D seismic volume(s) centered on the well location itself.
 - Concern: highly restricted access for 3D until fleet departs to acquire data
 - Time lapse repeats of either, or both, of the above to indicate stability and no change.
 - Degree of Ambiguity: low - with repeated volumes showing long term stability
 - *Passive: Seafloor Nodes*
 - Install Seabed passive listening array to identify subsurface events and pin point them in XYZ location
 - Slow data turn round, model driven processing, however once installed provides ongoing monitoring capability
 - Degree of Ambiguity: flow is continuing in subsurface.
 - Other methods: Visual Surveys (ROV), Sonar Surveys (AUV) and seabed deformation (tilt meter)

Aerial View of part of Source Area

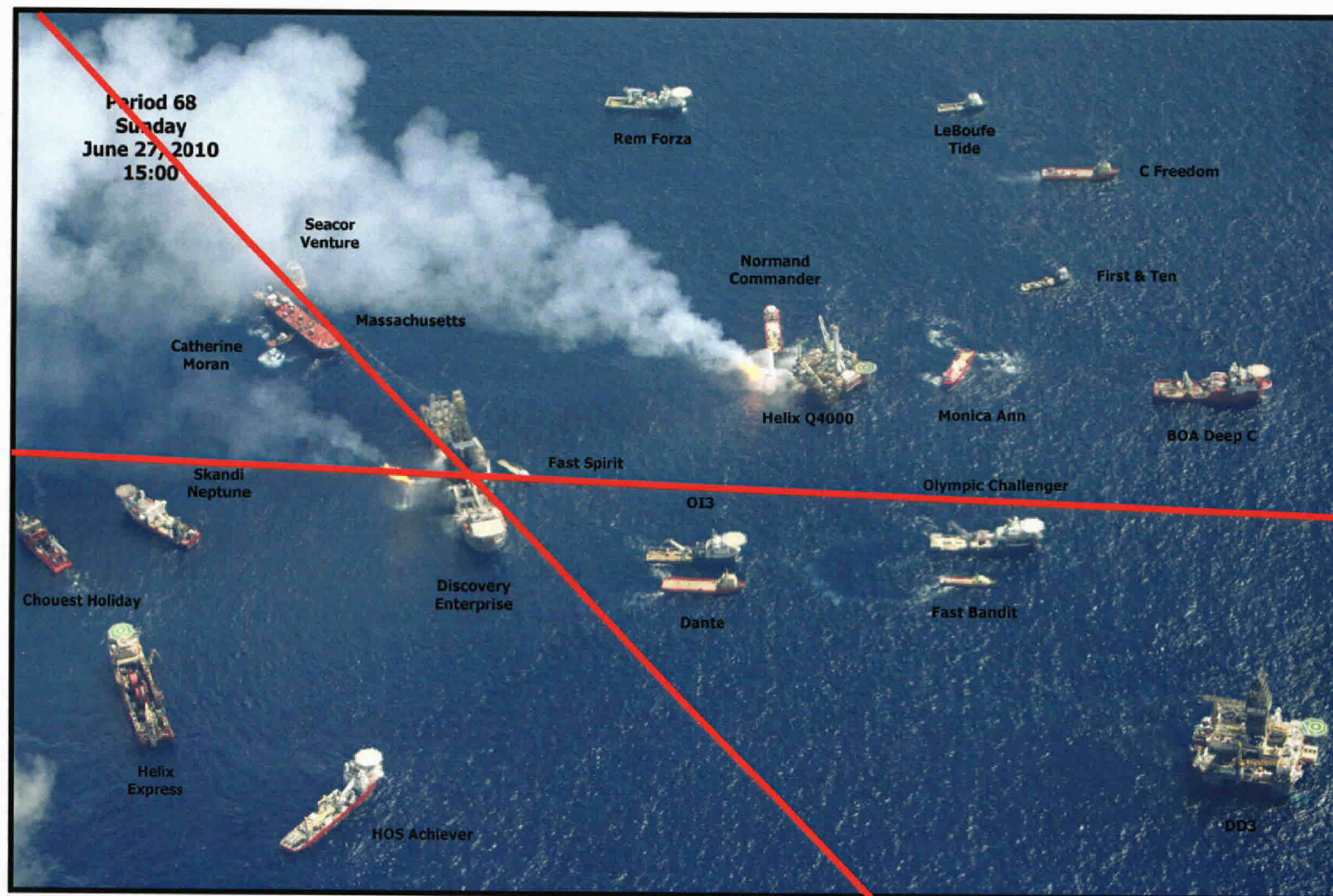



M110 Structure: Nominal Preferred Line Location

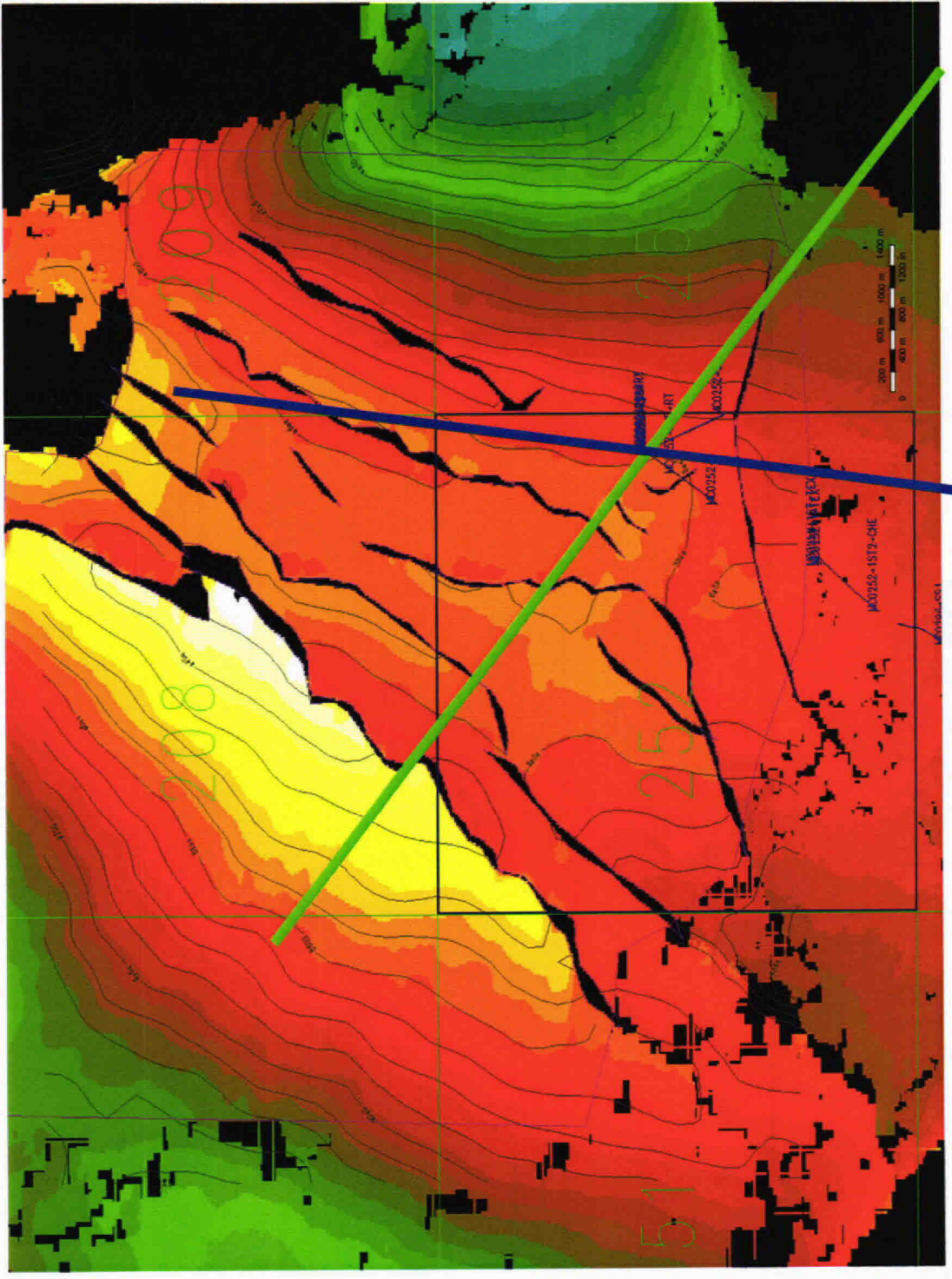

Safest Offset Line Locations

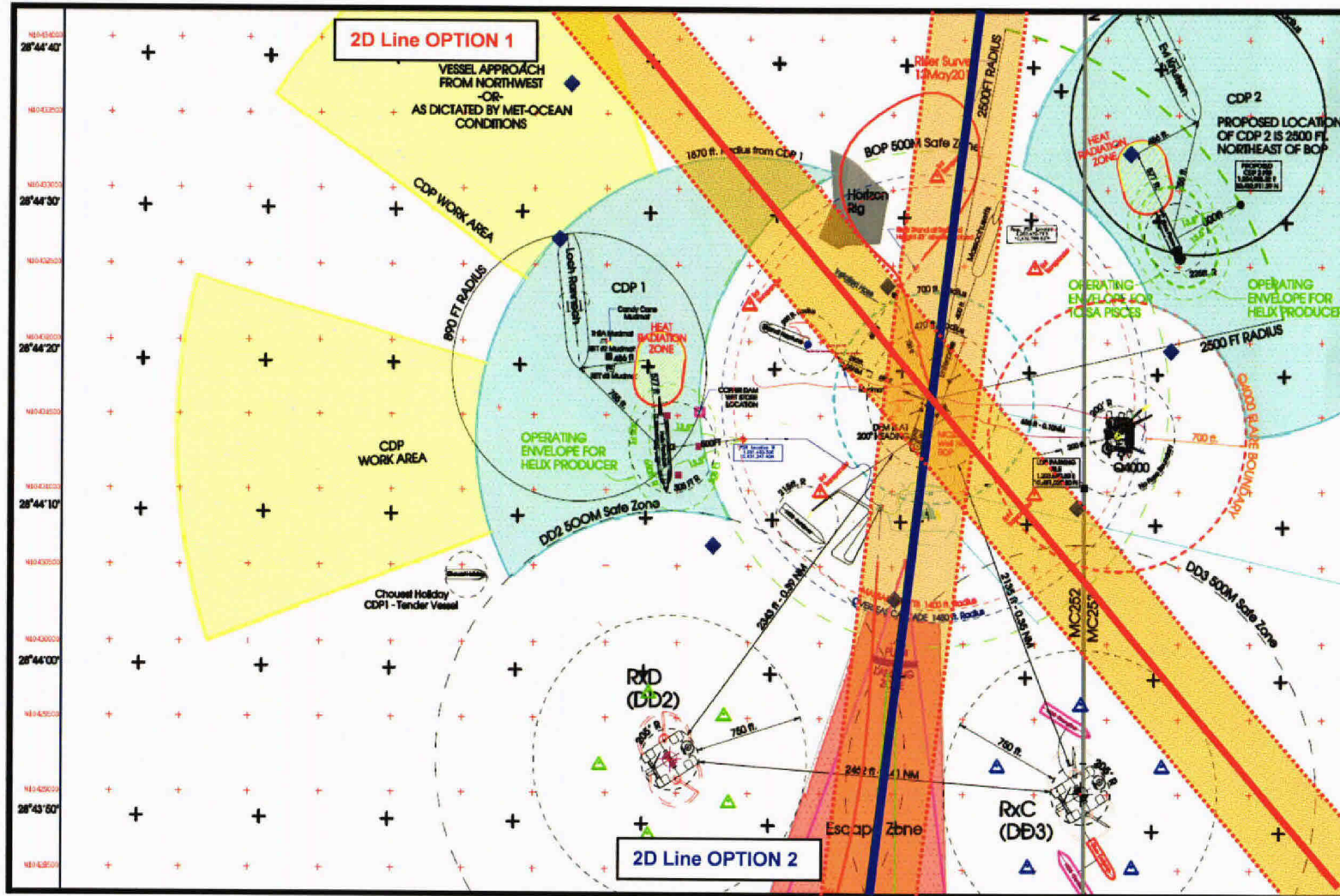



Detectability

- Given acquisition of lines pre-shut in and again post shut in what is the potential for detectability of change?
- If hydrocarbons are already capable of flow into formation, and have been flowing to formation for a significant period of time detectability of charge is good.
- If hydrocarbons are first forced into the formation as a result of shut-in, detectability is dependant on the volume being forced into the formation during shut in.
- Detectability is then dependant on: thickness of layer accepting charge and volume offered to the formation during that period.
- Seismic Bed Detectability: ~9 – 20ft bed thickness (assumes 40Hz at M110)
- Detectable Charge Volume:

| | |
|------------|---|
| 3000 bbls | Below detectability regardless of bed thickness |
| 6000 bbls | At limit of detectability for 10' bed thickness |
| 12000 bbls | Moderate to good opportunity for all cases |



Shut In – BOP Stack Monitoring

W. Leith McDonald
09 July 2010



BOP Stack Monitoring

BOP flanges and connectors to be monitored

- Horizon BOP to Wellhead Connector
- Horizon LMRP to BOP Connector
- Horizon Choke & Kill Lines on BOP/LMRP
- Flexjoint & Angle
- Flexjoint Riser Extension Flange
- Adaptor Spool Flange
- 3-Ram connector to Adaptor Spool
- 3-Ram Choke & Kill Lines
- 3-Ram Top connector opening

BOP Stack Monitoring Locations

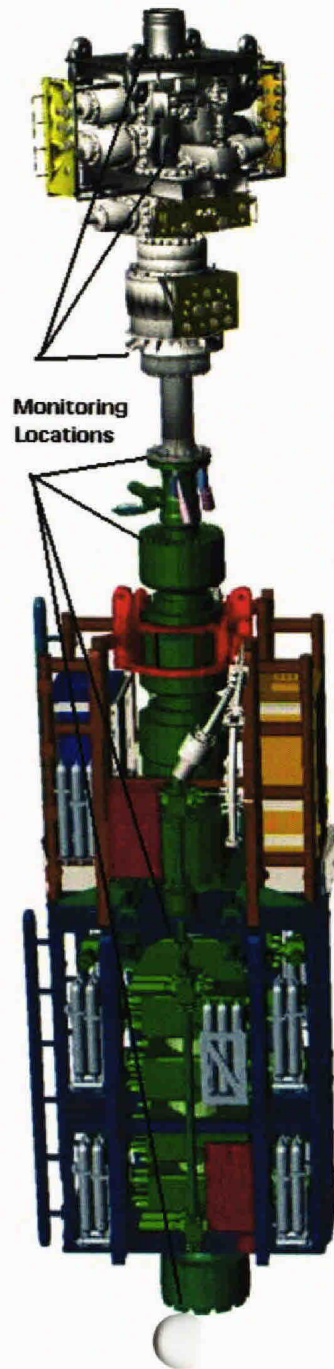



BOP Stack Monitoring

- Multiple Locations on BOP Stack to be monitored
- ROV Resourcing
 - 1 ROV dedicated to visual inspection
 - 1 ROV dedicated to choke operation
 - 2 ROVs in immediate area for pressure monitoring / visual inspections



MC252 Sensor Accuracy

July 8, 2010
Matt Gochnour

Pressure Transducers

Hot Stab Pressure Sensor

- Stellar Technology Incorporated (STI) Transducer
 - Model GT1600
 - Scaled and Rated to 20K psi
 - Tested to 10K psi
 - Accuracy (per data sheet) quoted at 0.1% for static conditions. (20 psi)

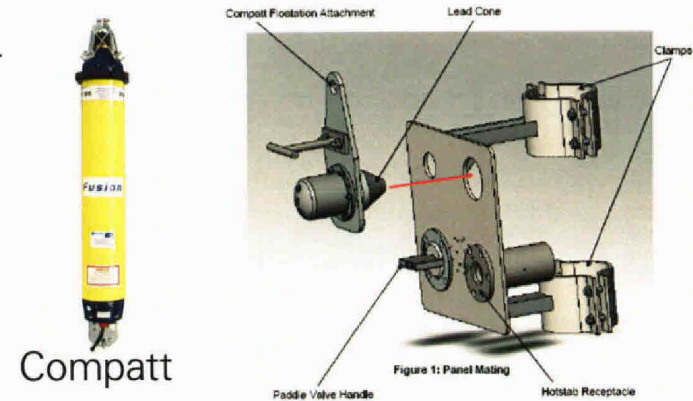

3 Ram Stack Integral Pressure Sensors (2 Pressures)

- Teledyne Cormon transducers
 - Pressure: 4mA -> 0 psi; 20mA -> 15k psi
 - Calibration data suggests error band of < 0.2% (30psi)

Data Transmission:

- PPT will interface with the acoustic networking system. Roughly 15 seconds between consecutive data points can be expected.



Pressure transducers and panel on 3-ram capping stack

Acoustic Error



- Sonardyne Compatt 5 units are fitted with a 16 bit A/D converter
- Only 12 bits are used to format the acoustic message
- Accuracy of acoustics is known to be +/- 1 bit
- 1 bit = 1.22 mV (5 V / 4095)
- Sensitivity (psi / volt) depends on pressure sensor range

| Pressure Range | Error |
|----------------|--------------|
| 20K | +/- 4.88 psi |
| 15K | +/- 3.66 psi |
| 10K | +/- 2.44 psi |



Network Overview

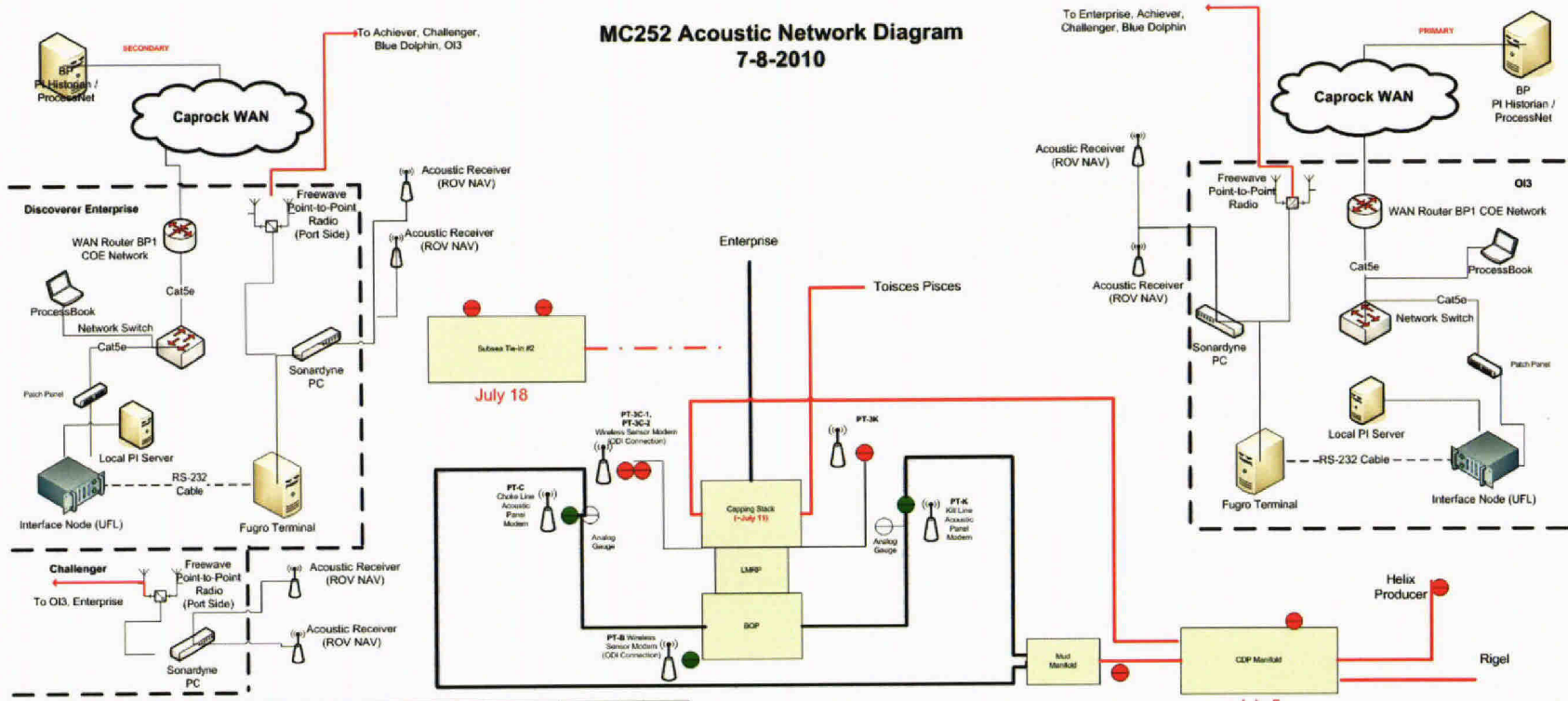

| Tag | Descriptor | Transducer Serial # | Address | Base Units | Engineering Units | Gain & Offset |
|---------|---|---------------------|---------|------------|-------------------|-----------------------------------|
| PT-B | Pressure below BOP | 301 | 101 | 1-5 VDC | 0-20000 psi | |
| PT-B | Spares acoustic modems for Pressure below BOP | 305 | 305 | 1-5 VDC | 0-20000 psi | |
| PT-C | Choke Line Pressure | 9850 | 302 | 0-5 VDC | 0-20000 psi | Gain = 4425.89, Offset = -2352.81 |
| PT-K | Kil Line Pressure | 9837 | 303 | 0-5 VDC | 0-20000 psi | Gain = 4424.05, Offset = -2199.25 |
| PT-3K | 3 Ram Stack Kil Line Pressure | 9803 | 304 | 0-5 VDC | 0-20000 psi | Gain = 4460.06, Offset = -2367.91 |
| PT-3K | Spares 3 Ram Stack Kil Line Pressure | 9850 | 305 | 0-5 VDC | 0-20000 psi | Gain = 4423.66, Offset = -2104.56 |
| PT-3C-1 | 3 Ram Stack Choke Line Pressure-1 | | 202 | 1-5 VDC | 0-15000 psi | |
| PT-3C-2 | 3 Ram Stack Choke Line Pressure-1 | | 203 | 1-5 VDC | 0-15000 psi | TBD |
| CDP-1 | CDP Mankind Inlet from 3 Ram Stack | 99038 | 208 | 0-5 VDC | 0-20000 psi | Gain = 4462.67, Offset = -2104.85 |
| CDP-2 | CDP Mankind 1 | 94392 | 208 | 0-5 VDC | 0-20000 psi | Gain = 4430.60, Offset = -2300.81 |
| CDP-3 | CDP Mankind Lower Rise Assembly | 98034 | 207 | 0-5 VDC | 0-20000 psi | Gain = 4387.78, Offset = -2218.62 |
| CDP-4 | CDP Mankind Upper Rise Assembly | 10501 | 208 | 0-5 VDC | 0-20000 psi | Gain = 4467.22, Offset = -2270.13 |
| CDP-5 | CDP Mankind Rigel Export | 61362 | 209 | 0-5 VDC | 0-20000 psi | Gain = 4437.01, Offset = -2484.42 |
| CDP-6 | CDP Mankind Inlet From Mud Mankind | 78504 | 210 | 0-5 VDC | 0-20000 psi | Gain = 4380.81, Offset = -2275.44 |
| | Spares | 78434 | 211 | 0-5 VDC | 0-20000 psi | Gain = 4411.80, Offset = -2287.13 |
| | Spares | 78501 | 212 | 0-5 VDC | 0-20000 psi | Gain = 4434.14, Offset = -2278.64 |
| SS2-1 | Subsea Tie-In Pressure 1 | | | | | |
| SS2-2 | Subsea Tie-In Pressure 2 | | | | | |

4-20mA Transmitters

$$\text{Scaled Value} = \frac{(\text{Raw Value} - \text{Raw Min}) * (\text{Max Scaled} - \text{Min Scaled})}{(\text{Raw Max} - \text{Raw Min})}$$

Stellar Transmitters

$$\text{Scaled Value} = (\text{Raw Value} * \text{Gain}) + \text{Offset}$$

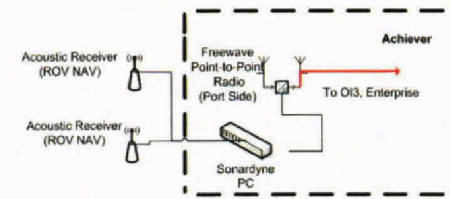



MC 252 Hydrocarbon Measurement Overview

Charles Marth
July 9, 2010



Enterprise

Separated Hydrocarbons are Measured by Two Inlet Separators each with:

- One 3" Oilgear Rotron PV (Proportional Velocity) Oil Meter
- One 6" Barton Master Orifice Fitting for Gas

Hydrocarbon Liquids:

- Custody transfer occurs during lightering operations from shipping vessel at onshore facility
- Measured in storage tanks strapping/sounding method
- Separator oil meters primarily used for operational purposes

Collected Hydrocarbon Gas:

- Separator volumes determined by orifice meter EFM
- Any unmetered residual flash gas determined by applying a flash factor to the metered oil
- Total gas volume = measured separator gas + calculated flash gas

Q4000



Separated Hydrocarbons are Measured By Inlet Separator with:

- One 3" Oilgear Rotron PV (Proportional Velocity) Oil Meter
- One 2" Oilgear Rotron PV (Proportional Velocity) Oil Meter
- One 6" Barton Master Orifice Fitting for Gas

Hydrocarbon Liquids:

- Metered at the liquid outflow of the test separator
- Inline VX multiphase meter used to monitor separator meter performance

Hydrocarbon Gas:

- Separator volume determined by orifice meter EFM
- Any unmetered residual flash gas determined by applying a flash factor to the metered oil
- Total gas volume = measured separator gas + calculated flash gas



Producer 1

Separated Hydrocarbons are Measured By Inlet Separator at:

- Two Inlet Separators
- Low Pressure Separator
- Degasser

Hydrocarbon Liquids:

- Custody transfer occurs during lightering operations from shipping vessel at onshore facility
- Metered with a 6" NuFlo turbine meter at the outlet of the dry oil tank when offloading to storage vessel

Hydrocarbon Gas:

- Separator volumes determined by orifice meter EFM
- Any unmetered residual flash gas determined by applying a flash factor to the metered oil
- Total gas volume = measured separator gas + calculated flash gas



Measurement Oil Checks

Enterprise

- Separator oil meter volume is compared to receiving vessel tank soundings (currently within +/- 4%)
- Separator oil meter volume is diverted to 100 bbl tank for volume comparison

Q4000

- Separator oil meter volume is compared to Vx Multiphase meter (currently within +/- 5%)
- Separator oil meter volume is diverted to 100 bbl tank for volume comparison

Producer 1

- Oil metering will be at ~atmospheric pressure, a spare 6" oil meter will be available for use if indicated
- Metered oil volumes will be monitored against tank gauging of storage vessel



Time Synchronization

Kate Baker
July 9, 2010

Time synchronization of clocks

- On board data loggers are time synchronized within their system but there is no requirement for synchronization across systems
- PT, Q4000 flow, Enterprise flow and Enterprise boarding pressure data acquisition systems and video were not synchronized during the period 6/26 – 6/30
- Time synchronization survey performed on 7/4 showed differences in clocks based on Coordinated Universal Time (UTC) – 05:00:00 (CDT)

| Clock | UTC difference on 7/4 | Time read at 12:00:00 UTC | Data stamped |
|----------------------------|-----------------------|---------------------------|--------------------------------|
| Q4000 acquisition computer | + 3 min 18 sec | 12:03:18 | Q4000 flow |
| Enterprise TDA | + 3 min 16 sec | 12:03:16 | Boarding pressure, flow, video |
| Millenium86 ROV Pilot PC | - 1 min 14 sec | 11:58:46 | PT data |

Pressure & flow recording interval and reference time



Topside Facilities

- Enterprise boarding pressure is recorded every 1 minute; Enterprise and Q4000 report oil flows every 15 minutes
- Time for both pressure and flow recordings is datumed to the ship-board Insight computer time.

Subsea Choke

- Choke setting change times and sizes will be recorded manually in the operations room as the order is given/executed.
- Time will be datumed to UTC – 5:00:00

Horizon BOP Stack and 3-Ram Capping Stack Pressure Transducers

- One ROV can monitor PT_B with a frequency of 1 reading per gauge every 4 seconds.
- Another ROV can monitor the 2 pressure transducers in the 3-Ram capping stack and 1 stabbed pressure transducer with a frequency of 1 reading per gauge every 4 seconds.
- Pressure sensor readings reference the time clock in the Fugro terminal server located on one of the ROV polling vessels.



Shut the well in on paper
Potential Outcomes and Responses

9 July, 2010



Potential Outcomes and Responses

| Shut in Pressure | Interpretation | Response |
|------------------|---|------------------|
| $p > x'$ | Good Integrity (v low leakage) | a, b, c, d, or e |
| $x' < p < x$ | Questionable integrity (leakage or depletion) | a, b, or c |
| $p < x$ | Poor Integrity | a |
| | Failed Test | |

Possible responses

- a. Keep system operating as near current conditions as practicable.
- b. Use capability to apply some extra back-pressure.
- c. Shut well in for limited periods (eg Hurricane)
- d. Shut well in for extended periods.
- e. Top Kill well using 3 Ram stack.

