

**From:** DWH, Toolpusher (Deepwater Horizon)  
**Sent:** Saturday, January 30, 2010 2:10 PM  
**To:** DWH, AsstDriller (Deepwater Horizon)  
**Subject:** MACONDO PART 1  
**Attachments:** Macondo\_Drilling\_Sec01\_Well\_Information NSC.pdf; APD approval (print pg 2 - 29 goes at end of appendix).pdf; macondo drlg program cover.pdf; Macondo\_Drilling\_a\_Spines.pdf

**RANDY EZELL**  
**SR. TOOLPUSHER**  
**TRANSOCEAN DEEPWATER HORIZON**  
[toolpusher.dwh@deepwater.com](mailto:toolpusher.dwh@deepwater.com)  
713-232-8262

**Form MMS 123A/123S - Electronic Version**  
**Application for Permit to Drill a New Well**

**Lease** G32306    **Area/Block** MC 252    **Well Name** 001    **ST** 00    **BP** 00    **Well Type** Exploration  
**Application Status** Approved    **Operator** 02481    **BP Exploration & Production Inc.**

**Pay.gov**    **Amount:**    **Pay.gov**  
**Amount:** \$1,959    **Tracking ID:** EWL-APD-8404    **Tracking ID:** 24VFAUT8

**General Well Information**

<b>API Number</b> 608174116900	<b>Approval Date</b> 05/22/2009	<b>Approved By</b> Frank Patton
<b>Date of Request</b> 05/13/2009	<b>Req Spud Date</b> 06/15/2009	<b>Kickoff Point</b> N/A
<b>Water Depth (ft.)</b> 4992	<b>Drive Size (in)</b> 36	<b>Mineral Code</b> Hydrocarbon
<b>RKB Elevation</b> 89	<b>Drive Depth (ft.)</b> 5361	<b>Subsea BOP</b> Yes
<b>Verbal Approval Date</b>		<b>Verbal Approval By</b>

**Proposed Well Location**

**Surface Location**

<b>LEASE (OCS)</b> G32306	<b>Area/Block</b> MC 252	<b>Authority</b> Federal Lease
<b>Entered NAD 27 Data</b>	<b>Calculated NAD 27 Departures</b>	<b>Calculated NAD 27 X-Y Coordinates</b>
<b>Lat:</b> 28.73836889	N 6857	<b>X</b> 1202802.892336
<b>Lon:</b> -88.36593389	E 1037	<b>Y</b> 10431702.916855
<b>Surface Plan</b>	<b>Plan Lease (OCS)</b> G32306	<b>Area/Block</b> MC 252

**Bottom Location**

<b>LEASE (OCS)</b> G32306	<b>Area/Block</b> MC 252
<b>Entered NAD 27 Data</b>	<b>Calculated NAD 27 Departures</b>
<b>Lat:</b> 28.73836889	N 6857
<b>Lon:</b> -88.36593389	E 1037
<b>Bottom Plan</b>	<b>Plan Lease (OCS)</b> G32306

**Approval Comments**

The APD is approved with the following cautions/conditions:  
Please use caution while drilling because of possible shallow gas at 4370 feet to 4820 feet BML.  
Please use caution while drilling because of a moderate potential shallow water flow at 1832 feet to 1944 feet, 3200 feet to 3367 feet 3760 feet to 3960 feet and 437- feet to 4600 feet BML.  
Please be reminded that an APM should be submitted with a final surveyed surface location plat (in NAD 83), KB, and water depth as soon as they are determined.  
If the water depth is greater than 800 meters (2,624 feet) and you plan to leave the wellhead on the seafloor after plugging and abandoning of this well, you are required to obtain MMS approval as soon as possible and no later than 5 work days prior to the start of plugging operations for the well so that MMS will have time to get concurrence from the Navy. Your

**Form MMS 123A/123S - Electronic Version**  
**Application for Permit to Drill a New Well**

**Lease** G32306    **Area/Block** MC 252    **Well Name** 001    **ST** 00    **BP** 00    **Well Type** Exploration  
**Application Status** Approved    **Operator** 02481    BP Exploration & Production Inc.

request should contain the following information: Lat. and Long. coordinates, water depth, wellhead height, completion guide base height, and aerial extent. If the water depth is greater than 1,666 meters (5000 feet), then concurrence from the Navy is not required. The approval of waiver to leave a wellhead on the sea floor in water depth less than 800 meters (2,624 feet) will be limited to request that pose a mechanical problem or a safety concern, such as diver safety when excavating around the wellhead on the seafloor. The waiver must be approved by the District Manager and concurrence from the Navy must be obtained.

**Form MMS 123A/123S - Electronic Version**  
**Application for Permit to Drill a New Well**

**Lease** G32306    **Area/Block** MC 252    **Well Name** 001    **ST** 00    **BP** 00    **Well Type** Exploration  
**Application Status** Approved    **Operator** 02481    BP Exploration & Production Inc.

**Geologic Information**

<b>H2S Designation</b> Absent	<b>H2S TVD</b>
<b>Anticipated Geologic Markers</b>	
<b>Name</b>	<b>Top MD</b>
Reticulofenestra pseudoumbilicus	7060
Catinaster mexicanus	9100
Catinaster coalitus	13145
Discoaster kugleri	14153
Cyclicargolithus floridanus	17481
Globorotalia peripheroronda	18400
Sphenolithus heteromorphus	19120
Discoaster petaliformis	19594

**Rig Information**

<b>RIG SPECIFICATIONS</b>		<b>ANCHORS</b>	Yes
<b>Rig Name</b>	T.O. MARIANAS		
<b>Type</b>	SEMISUBMERSIBLE	<b>ID Number</b>	44574
<b>Function</b>	DRILLING	<b>Constucted Year</b>	1979
<b>Shipyard</b>	MITSIBUSHI	<b>Refurbished Year</b>	
<b>RATED DEPTHS</b>			
<b>Water Depth</b>	7000	<b>Drill Depth</b>	25000
<b>CERTIFICATES</b>			
<b>ABS/DNV</b>	08/31/2013	<b>Coast Guard</b>	12/13/2009
<b>SAFE WELDING AREA</b>			
<b>Approval Date</b>	10/22/1998	<b>District</b>	1
<b>Remarks</b>	Water Depth Rating increased from 6000 ft to 7000 ft based on email from Kenny Brown, Mariana Rig Manager - DJT		

**Form MMS 123A/123S - Electronic Version**  
**Application for Permit to Drill a New Well**

**Lease** G32306    **Area/Block** MC 252    **Well Name** 001    **ST** 00    **BP** 00    **Well Type** Exploration  
**Application Status** Approved    **Operator** 02481    BP Exploration & Production Inc.

Number	Question	Response	Response Text
1	Will you maintain quantities of mud and mud material (including weight materials and additives) sufficient to raise the entire system mu	YES	
2	If hydrocarbon-based drilling fluids were used, is the drilling rig outfitted for zero discharge and will zero discharge procedures be followed?	N/A	
3	If drilling the shallow casings strings riserless, will you maintain kill weight mud on the rig and monitor the wellbore with an ROV to ensure that i	YES	
4	If requesting a waiver of the conductor casing, have you submitted a log to MMS G&G that is with in 500 feet of the proposed bottom hole locat	N/A	
5	Will the proposed operation be covered by an EPA Discharge Permit? (please provide permit number in comments for this question)	YES	NOI has been submitted but permit number has not yet been assigned.
6	Will all wells in the well bay and related production equipment be shut-in when moving on to or off of an offshore platform, or from well to w	N/A	

**Form MMS 123A/123S - Electronic Version**  
**Application for Permit to Drill a New Well**

**Lease** G32306    **Area/Block** MC 252    **Well Name** 001    **ST** 00    **BP** 00    **Well Type** Exploration  
**Application Status** Approved    **Operator** 02481    BP Exploration & Production Inc.

**Permit Attachments**

File Type	File Description	Status
-----------	------------------	--------

**Required Attachments**

pdf	Proposed Well Location Plat	Attached
pdf	Drilling prognosis and summary of drilling, cementing, and mud processes	Attached
pdf	Directional Program	Attached
pdf	Pore pressure (PP), Mud Weight (MW), and Fracture Gradient (FG) Plot	Attached
pdf	Proposed Wellbore Schematic	Attached
pdf	Engineering Calculation	Attached
pdf	BOP & Diverter Schematics with Operating Procedures	Attached

**Optional/Supplemental Attachments**

pdf	Departure List	Attached
pdf	Mooring approval	Attached
PDF	Application for Permit to Drill	Attached

**Contacts Information**

<b>Name</b>	Scherie Douglas
<b>Company</b>	02481                      BP Exploration & Production Inc.
<b>Phone Number</b>	281-366-6843
<b>E-mail Address</b>	scherie.douglas@bp.com
<b>Contact Description</b>	Regulatory
<b>Name</b>	Heather Powell
<b>Company</b>	02481                      BP Exploration & Production Inc.
<b>Phone Number</b>	281-504-0984
<b>E-mail Address</b>	heather.powell@bp.com
<b>Contact Description</b>	Regulatory

**Form MMS 123A/123S - Electronic Version**  
**Application for Permit to Drill a New Well**

**Lease** G32306    **Area/Block** MC 252    **Well Name** 001    **ST** 00    **BP** 00    **Well Type** Exploration  
**Application Status** Approved    **Operator** 02481    **BP Exploration & Production Inc.**

**Well Design Information**

Interval Number 1		Type Casing			Name		Conductor	
Section Number	Casing Size (in)	Casing Weight (lb/ft)	Casing Grade	Burst Rating	Collapse Ratin (psi)	Depth (ft) MD	Depth (ft) TVD	Pore Pressure (ppg)
1	28.000	218.0	X-52	2437	952	6275	6275	8.6

GENERAL INFORMATION			PREVENTER INFORMATION			TEST INFORMATION		
Hole Size (in)	32.500		Type	No Preventers		Annular Test (psi)	0	
Mud Weight (ppg)	8.6		Size (in)	N/A		BOP/Diverter Test (psi)	0	
Mud Type Code	Gelled Sea Water		Wellhead Rating (psi)	0		Test Fluid Weight (ppg)	0.0	
Fracture Gradient (ppg)	9.8		Annular Rating (psi)	0		Casing/Liner Test (psi)	0	
Liner Top Depth (ft)			BOP/Diverter Rating (psi)	0		Formation Test (ppg)	0.0	
Cement Volume (cu ft)	2000							

Interval Number 2		Type Casing			Name		Surface	
Section Number	Casing Size (in)	Casing Weight (lb/ft)	Casing Grade	Burst Rating	Collapse Ratin (psi)	Depth (ft) MD	Depth (ft) TVD	Pore Pressure (ppg)
1	22.000	277.0	X-80	7955	6670	5161	5161	8.6
2	22.000	224.0	X-80	6363	3876	8000	8000	9.3

GENERAL INFORMATION			PREVENTER INFORMATION			TEST INFORMATION		
Hole Size (in)	26.000		Type	Blowout		Annular Test (psi)	5000	
Mud Weight (ppg)	9.5		Size (in)	18.75		BOP/Diverter Test (psi)	6500	
Mud Type Code	Water Base		Wellhead Rating (psi)	15000		Test Fluid Weight (ppg)	8.6	
Fracture Gradient (ppg)	11.1		Annular Rating (psi)	10000		Casing/Liner Test (psi)	3400	
Liner Top Depth (ft)			BOP/Diverter Rating (psi)	15000		Formation Test (ppg)	11.1	
Cement Volume (cu ft)	3300							

**Form MMS 123A/123S - Electronic Version**  
**Application for Permit to Drill a New Well**

**Lease** G32306    **Area/Block** MC 252    **Well Name** 001    **ST** 00    **BP** 00    **Well Type** Exploration  
**Application Status** Approved    **Operator** 02481    **BP Exploration & Production Inc.**

Interval Number 3		Type	Liner	Name		Intermediate		
Section Number	Casing Size (in)	Casing Weight (lb/ft)	Casing Grade	Burst Rating	Collapse Ratin (psi)	Depth (ft) MD	Depth (ft) TVD	Pore Pressure (ppg)
1	18.000	117.0	P-110	6680	2110	9900	9900	10.4

GENERAL INFORMATION			PREVENTER INFORMATION			TEST INFORMATION		
Hole Size (in)	22.000		Type	Blowout		Annular Test (psi)	5000	
Mud Weight (ppg)	10.6		Size (in)	18.75		BOP/Diverter Test (psi)	6500	
Mud Type Code	Synthetic Base		Wellhead Rating (psi)	15000		Test Fluid Weight (ppg)	10.6	
Fracture Gradient (ppg)	12.3		Annular Rating (psi)	10000		Casing/Liner Test (psi)	2800	
Liner Top Depth (ft)	7600.0		BOP/Diverter Rating (psi)	15000		Formation Test (ppg)	12.3	
Cement Volume (cu ft)	1040							

Interval Number 4		Type	Casing	Name		Intermediate		
Section Number	Casing Size (in)	Casing Weight (lb/ft)	Casing Grade	Burst Rating	Collapse Ratin (psi)	Depth (ft) MD	Depth (ft) TVD	Pore Pressure (ppg)
1	16.000	97.0	P-110	6920	2340	12500	12500	11.6

GENERAL INFORMATION			PREVENTER INFORMATION			TEST INFORMATION		
Hole Size (in)	20.000		Type	Blowout		Annular Test (psi)	5000	
Mud Weight (ppg)	11.8		Size (in)	18.75		BOP/Diverter Test (psi)	6500	
Mud Type Code	Synthetic Base		Wellhead Rating (psi)	15000		Test Fluid Weight (ppg)	11.8	
Fracture Gradient (ppg)	13.6		Annular Rating (psi)	10000		Casing/Liner Test (psi)	3100	
Liner Top Depth (ft)			BOP/Diverter Rating (psi)	15000		Formation Test (ppg)	13.6	
Cement Volume (cu ft)	930							

Interval Number 5		Type	Liner	Name		Intermediate		
Section Number	Casing Size (in)	Casing Weight (lb/ft)	Casing Grade	Burst Rating	Collapse Ratin (psi)	Depth (ft) MD	Depth (ft) TVD	Pore Pressure (ppg)
1	13.625	88.2	Q-125	10030	4800	15300	15300	12.9

GENERAL INFORMATION			PREVENTER INFORMATION			TEST INFORMATION		
Hole Size (in)	16.000		Type	Blowout		Annular Test (psi)	5000	
Mud Weight (ppg)	13.1		Size (in)	18.75		BOP/Diverter Test (psi)	6500	
Mud Type Code	Synthetic Base		Wellhead Rating (psi)	15000		Test Fluid Weight (ppg)	13.1	
Fracture Gradient (ppg)	14.7		Annular Rating (psi)	10000		Casing/Liner Test (psi)	2000	
Liner Top Depth (ft)	12200.0		BOP/Diverter Rating (psi)	15000		Formation Test (ppg)	14.7	
Cement Volume (cu ft)	410							



**Form MMS 123A/123S - Electronic Version**  
**Application for Permit to Drill a New Well**

**Lease** G32306    **Area/Block** MC 252    **Well Name** 001    **ST** 00    **BP** 00    **Well Type** Exploration  
**Application Status** Approved    **Operator** 02481    BP Exploration & Production Inc.

<b>Interval Number</b> 6		<b>Type</b> Open Hole			<b>Name</b> Open Hole			
Section Number	Casing Size (in)	Casing Weight (lb/ft)	Casing Grade	Burst Rating	Collapse Ratin (psi)	Depth (ft)		Pore Pressure (ppg)
						MD	TVD	
1						20200	20200	14.0

<b>GENERAL INFORMATION</b>			<b>PREVENTER INFORMATION</b>			<b>TEST INFORMATION</b>		
<b>Hole Size (in)</b>	14.000		<b>Type</b>	Blowout		<b>Annular Test (psi)</b>	5000	
<b>Mud Weight (ppg)</b>	14.2		<b>Size (in)</b>	18.75		<b>BOP/Diverter Test (psi)</b>	6500	
<b>Mud Type Code</b>	Synthetic Base		<b>Wellhead Rating (psi)</b>	15000		<b>Test Fluid Weight (ppg)</b>	0.0	
<b>Fracture Gradient (ppg)</b>	16.1		<b>Annular Rating (psi)</b>	10000		<b>Casing/Liner Test (psi)</b>	0	
<b>Liner Top Depth (ft)</b>			<b>BOP/Diverter Rating (psi)</b>	15000		<b>Formation Test (ppg)</b>	0.0	
<b>Cement Volume (cu ft)</b>								

PAPERWORK REDUCTION ACT OF 1995 (PRA) STATEMENT: The PRA (44 U.S.C. 3501 et seq. Requires us to inform you that we collect this information to obtain knowledge of equipment and procedures to be used in drilling operations. MMS uses the information to evaluate and approve or disapprove the adequacy of the equipment and/or procedures to safely perform the proposed drilling operation. Responses are mandatory (43 U.S.C. 1334). Proprietary data are covered under 30 CFR 250.196. An agency may not conduct or sponsor, and a person is not required to respond to, a collection of information unless it displays a currently valid OMB Control Number. Public reporting burden for this form is estimated to average 27 hours per response, including the time for reviewing instructions, gathering and maintaining data, and completing and reviewing the form. Direct comments regarding the burden estimate or any other aspect of this form for the Information Collection Clearance Officer, Mail Stop 4230, Minerals Management Service, 1849

## **Prospect Overview**

Macondo is a moderate depth Miocene prospect in the Mississippi Canyon area. The prospect is located entirely outside of any salt body. It is located approximately 24 miles north of BP's Isabela discovery which was drilled in MC 562 during 2006. The primary target for the Macondo prospect is the M56, which was the same as Isabela. The target depth for Macondo is approximately 18,400'. The well will be drilled to a TD of 20,200' to test the older Miocene section below the targeted M56. Seismic data quality over this prospect is very good since there is no salt involved. The well will be drilled as a vertical hole from the "A" location as permitted in the approved Exploration Plan for MC 252.

## **Drilling Plan Summary**

The Macondo well will be drilled with the Transocean "Marianas" moored Semi-Submersible rig in Mississippi Canyon Block 252 at a proposed surface location of 6,943' FNL and 1,036' FEL, in a water depth of 4,992 ft.

A structural string of 36" x 1-1/2" wall will be jetted (drilled) into position at approximately 280' below the mud line (~10' stick up). After completion of the jetting operations and appropriate waiting time, the running tool will be released and a 26" x 32-1/2" hole will be drilled riserless with seawater and viscous sweeps to an expected total depth of 6,275' md/tvd. There is a low potential for shallow water flow within this section. "Pump & dump" method will remain a contingency in the event any abnormally pressured sands are encountered.

At section TD, an 11.5 ppg pad mud will be spotted and the well will be monitored for flow prior to pulling out of the hole. Once out of the hole, 28" casing will be run to TD and cemented to the mud line with Halliburton foamed Class H lead and tail. The inner string will be pulled out of the hole only after confirmation is made of no flow and no detectable wellhead subsidence.

A 26" hole will be drilled with seawater and viscous sweeps to an expected total depth of 8,000' md/tvd. There is a low potential for shallow flow within this section. "Pump & dump" method will remain a contingency in the event any abnormally pressured sands are encountered. At section TD, 11.5 ppg pad mud will be spotted in open hole while leaving 16.0 ppg mud in the rat hole. Once a static wellbore is verified, the 22", 1.0" wall casing will be run to TD along with the Dril-Quip 18-3/4" high pressure wellhead and 1.25" wall extension joints. After a successful cement job with Halliburton's foamed Class H lead and tail, the wellhead will be pre-loaded to 1,500,000 lbs. The running tool and inner string will be pulled and operations to run BOP and riser will commence.

Once the BOP and riser are successfully installed and tested (per APD), the 22" casing and B/S rams will be tested per the APD. The well will be displaced to Baroid's 10.0 ppg synthetic oil base mud while drilling out the float equipment. A Leak-off Test (LOT) will be performed after drilling out. The estimated fracture gradient is ~11.1 ppg EMW. This setting depth should give sufficient fracture gradient to achieve 18" casing point at 9,900' md/tvd.

An 18-1/8" x 22" hole will be drilled with SOBMs to a depth of 9900' md/tvd. At section TD, a 17.0 ppg pad mud will be spotted in the rathole prior to POOH for 18" liner. The 18" liner will be run

and cemented in place with Halliburton Class H lead and tail slurries. A Leak-off Test (LOT) will be performed after drilling out. The estimated fracture gradient is ~ 12.3 ppg EMW. This setting depth should give sufficient fracture gradient to achieve the 16" casing point at 12,500' md/tvd.

A 16-1/2" x 20" hole will be drilled with SOBM to 12,500' md/tvd. At section TD, a 17.0 ppg pad mud will be spotted in the rathole prior to POOH for 16" casing. After POOH, the 16" casing will be run and cemented in place with Halliburton Class H lead and tail slurries. A Leak-off Test (LOT) will be performed after drilling out. The estimated fracture gradient is ~13.6 ppg EMW. This setting depth should give sufficient fracture gradient to achieve the 13-5/8" casing point at 15,300' md/tvd.

A 14-3/4" x 16" hole will be drilled with SOBM to 15,300' md/tvd. At section TD, the rathole will be filled with 17.0 ppg pad mud prior to POOH for 13-5/8" liner. After POOH, the 13-5/8" liner will be run and cemented in place with Halliburton Class H lead and tail slurries. A Leak-off Test (LOT) will be performed after drilling out. The estimated fracture gradient is ~14.7 ppg EMW. This setting depth should give sufficient fracture gradient to achieve drilling to the TD of 20,200' md/tvd.

A 12-1/4"x 14" hole will be drilled to 20,200' md/tvd. The need for wireline evaluation of this interval will be determined by real time LWD data. A decision on the way forward will be made following evaluation of the open hole interval. The well will either be P&A'd or temporarily abandoned for future completion. Once the final evaluation program is complete, a decision will be made as to whether to sidetrack, TA well, or PA the well.

**Notes:**

MWD and LWD will be used in all intervals to assist with directional control, formation evaluation and pore pressure detection. Additionally, PWD will be utilized to monitor downhole static mud weights, equivalent circulating densities as well as assist in optimizing downhole hydraulics.

All intervals below the 22" casing include optional wireline evaluation programs. Execution of these evaluation programs will be based on real time LWD, paleo and pore pressure data.

During the drilling of all hole sections, the rig shall maintain a minimum inventory of 1000 sx of barite and 200 sx of gel/poly at all times.

## Shallow Water Flow Zone Management

An evaluation of shallow water flow (SWF) potential was carried out at the Macondo drilling location as part of BP's standard shallow hazard analysis. The data that formed the basis for this evaluation consist of:

- 3D seismic data: Approved by MMS for shallow hazard evaluation utility based on EP approval date April 6, 2009
- Offset well control: Drilling history, casing design, and nature of 3D seismic reflectors at nearby Texaco MC 252#1 and Dominion MC 296#1 wells (about 1.3 miles and 1.9 miles SW, respectively), Chevron's Gemini well in MC 292#1 (about 14 miles W-SW) and BP's Ariel Well MC 429#A1 (about 13 miles SE)
- Geohazard report: The proposed location of this well was selected based on the results of: a regional shallow hazards survey and study of MC208, MC252 and MC296 and portions of surrounding blocks conducted by KC Offshore in 1998 for Texaco Exploration and Production Inc. (Texaco) using HR2D seismic data integrated with 3D exploration seismic data; AND a shallow hazards report for MC252 and MC296 and vicinity produced by Fugro GeoServices, Inc. (Fugro) in 2003 for Dominion Exploration and Production Inc. (Dominion) based on exploration 3D seismic data – the seafloor mapping area for this report covered all of MC252 and MC296, whereas the subsurface mapping area only covered the southern half of MC252 and the northern half of MC296. Additionally, BP completed a site clearance letter for EP submittal at the proposed location based on 3D seismic data.

The seismic character of events at the proposed location was compared to the wells referenced above. No shallow water flow was recorded at the two closest offset wells, MC 252#1 and MC 296#1. The MMS SWF website notes a "low" severity SWF event was documented at the MC 292#1 well and MC 429#A1 well at about 1,784 ft and 1,738 ft below mudline (bml), respectively. The intervals noted as "low" severity SWF roughly correlate with three sand-prone intervals interpreted at the proposed Macondo location within the tophole section. These three potential sand-bearing zones are noted between approximate depths of 1,489 -1,620 ft, 1,832 – 1,944 ft and 1,944 – 2,533 ft bml at Macondo. Based on our seismic facies analysis of the data, and the general absence of reported significant SWF sands in offset wells, we risk the sand-prone intervals has having a low, moderate and low potential for SWF, respectively.

Three additional sand-prone intervals have been interpreted at 3,202 ft – 3,367 ft, 3,761 ft – 3,958 ft and 4,372 ft and 4,618 ft bml at Macondo. Although these zones have been assessed a moderate potential for SWF, they are below the depth of the planned first pressure containment 22-inch casing string.

The table below summarizes concerns and mitigations and meets API RP 65 best practices.

Concern	Mitigation
Site Selection	Drilling location selected to minimize shallow water flow risk. See discussion above. One "low" risk shallow water flow has been interpreted. See geologic top hole forecast on next page.
Identifying SWF	Downhole pressure while drilling (PWD), gamma ray and resistivity tools will be run in the drilling BHA to assist in identifying potential permeable sands or flow events. A shallow hazard observer will be on the rig during the tophole section to monitor logs.

Seafloor Monitoring	Rig based, remotely operated vehicle (ROV) will be on the seafloor monitoring riserless returns and checking for flow on connections. ROV will also be utilized to monitor returns during cementing. A shallow hazard observer will be on the rig during the tophole section to monitor the ROV.
Drilling Fluids	Risk of shallow water flow (SWF) has been interpreted as "low". All riserless intervals are planned to be drilled with seawater. Sufficient quantities of 16.4 ppg water based mud (WBM) will be on location for spotting weighted pad mud in the open hole and for well control in the riserless sections, should it be required.
Casing Point Selection	28" casing point selected at 6275' MD, above an intermediate "low" risk SWF. The 22" casing shoe is selected at 8000' MD, below the deeper "low" risk SWF zone. If a SWF is encountered, pump and dump contingency can be exercised with minimal risk to the jetted-in conductor shoe. The 22" is set above the interval expected to have a "low" probability of shallow gas, and a "moderate" probability of SWF.
Cementing	28" and 22" casing strings will be cemented (via inner string) to the mudline using foamed lead and non-foamed tail cement slurries. Cement returns will be verified with the ROV. Wellhead configuration includes an annular sealing mechanism that can be closed after cementing (to eliminate nitrogen breakout).
Well Control Response	SWF will be killed with weighted WBM. Pump and dump contingencies, using weighted WBM, would be initiated prior to drilling ahead.

MC252 "A" Mississippi Canyon 252 (OCS-G-32306)	Interpretation		Depth BSL (ft)	Depth BML (ft)	TWT BSL (sec)	Interval Thickness (ft)	Comments	Hazards Risk		
	Stratigraphy	Lithology						Shallow Gas	Shallow Water Flow	
	Seal floor		0		2.036	250	Relatively smooth seafloor, slopes ~3.0° to SE			
	Unit 1	Clay	250	4,992	2,130					
	Horizon 10			5,242			476	Hemipelagic clays with possible thin clay debris flows		
	Unit 2	Clay	726	5,716						
	Horizon 15			5,836			196	Interbedded marl clays and thin clay-prone debris flows		
	Horizon 20	Clay/Marl	844	5,836						
	Unit 3	Clay/Marl	1,042	6,034	2,416		447	Interbedded marl clays and possible marls Interbedded marine clays and possible marls Potential sands with shallow gas associated with overbank deposits to east		
	Horizon 30									
	Unit 4	Clay	1,489	6,451	2,570		131	Clay turbidites and debris flows		
	Horizon 34			1,620	6,612					
	Unit 5	Clay, silt and sand	2,533	6,451	2,912		299	Overbank channel levee clays and possible silts and sands		
	Horizon 36			1,824	6,612					
	Unit 6	Clay	2,832	6,824	3,006		370	Clay turbidites and thin debris flows		
	Horizon 38			6,824	2,685					
	Unit 6	Sands and silts	3,202	6,936	2,722		165	Continuous sands and silts with shallow gas to northwest		
	Horizon 40			3,337	6,936					
Unit 6	Clay and possible sands	3,761	8,753	3,268		394	Interbedded clay turbidites and thin clay-prone debris flows with possible sands			
Horizon 45			3,761	8,753						
Unit 6	Clay and possible silts	3,558	6,856	3,445		197	Massive clay-prone debris flow with possible silts			
Horizon 50			4,372	8,364						
Unit 6	Continuous sands	4,372	8,364	3,466		246	Interbedded clay turbidites and debris flows with locally continuous sands			
Horizon 60			4,616	3,536						
Unit 6	Continuous sands	5,328	10,320	3,734		710				
Horizon 60			5,328	3,734						



\*updated 5-6-09

MC 252 #1  
OCS-G-32306  
Attachment 9

Mark Hafle  
5/11/09

# BP GoM Deepwater Exploration

## Macondo Prospect - APD Schematic

OPERATOR:	BP	PARTNER:	None (TBD)	DATE:	5/11/2009_Rev1 APD Schematic
WELL NAME:	MC 252 #1, MACONDO PROSPECT, OCS-G-32306			PTD:	20,200' MD/TVD
FIELD / PROSPECT:	WILDCAT	AREA:	OFFSHORE	STATE:	LA
SURFACE LOCATION:	X=1,202,803.88 Y=10,431,817.00		RF ELEV:	89' (Marianas)	WD: 4992'
OBJECTIVE ZONE(S):	M56	RIG:	Transocean Marianas		

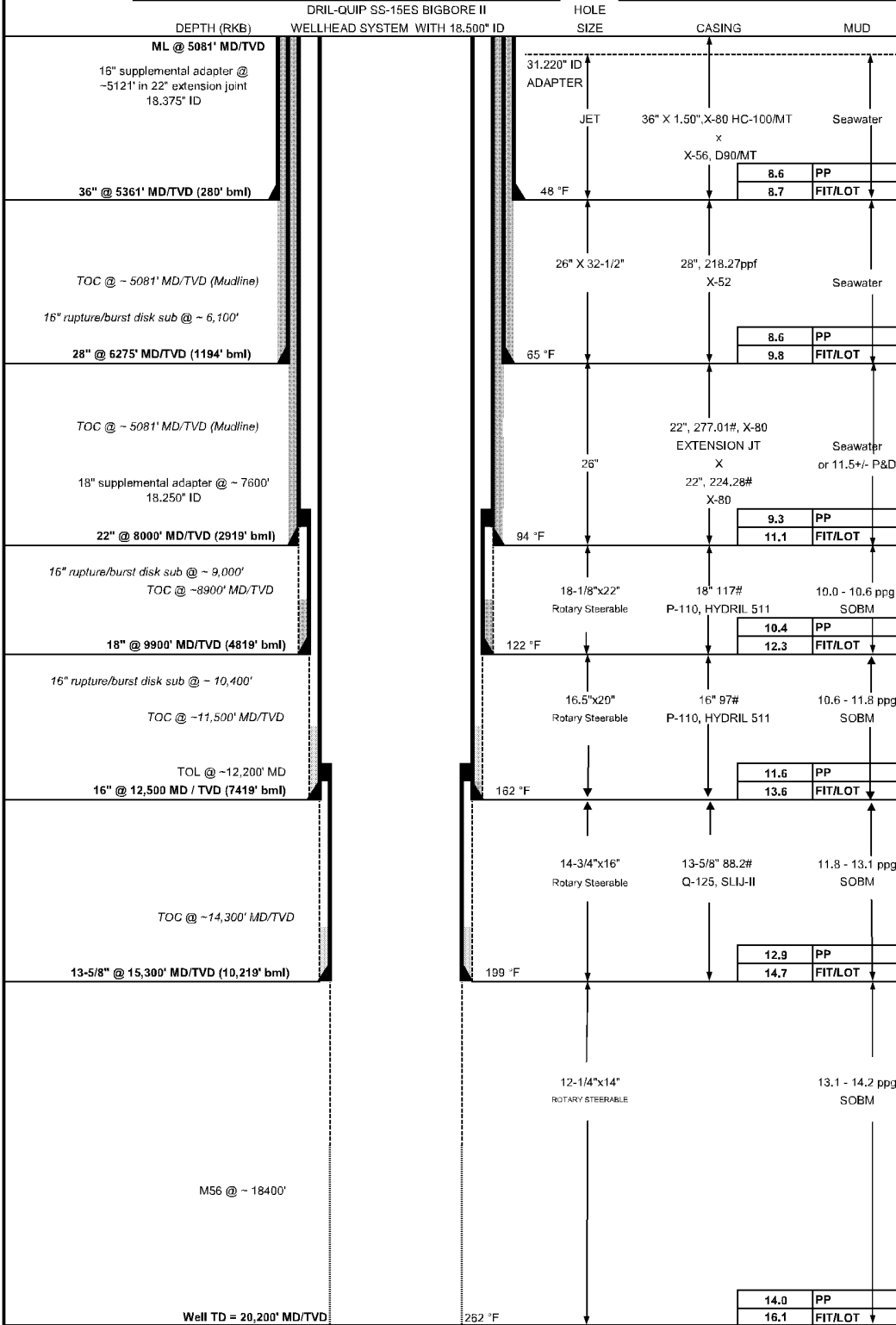

MC 252 #1  
OCS-G-32306  
Attachment 3

Mark Hafle  
5/11/09

Y = 10,438,560.00ft

X = 1,188,000.00ft

Notes:

- 1) All coordinate data in UTM Zone 16 North, NAD27, US survey feet unless otherwise noted;
- 2) All geodetic conversions transformed utilizing NADCON version 2.0 or better equivalent software;
- 3) Locations NOT in a Military Warning Area

NAD83 Data:

SHL Data  
MC252 No. 1  
ST00 BP00

Latitude 28°44'18.128"N  
Longitude 88°21'57.362"W

Proposed Well Location

MC252 OCS-G32306  
Well No. 1 ST00 BP00

X = 1,202,803.88ft UTM Zone 16 North  
Y = 10,431,617.00ft NAD27 - US Survey feet  
Latitude 28°44'17.277"N NAD27  
Longitude 88°21'57.340"W  
MD/TVD= 20,200ft  
Water depth = -4992ft

6943.00ft

1036.12ft

MC252  
BP E&P Inc  
OCS-G32306

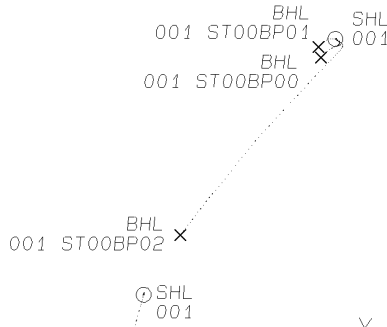

Y = 10,422,720.00ft

X = 1,203,840.00ft

Digital Copy

Signed & sealed original on file

Brian D. Autio Date: 8 May 2009

Registered Professional Land Surveyor  
State of Louisiana  
Registration Number 4818  
Employee of bp America, Inc  
(281) 366-4452

I, Brian D. Autio, hereby certify that the proposed surface location of BP EXPL & PROD. OCS-G32306 MC 252 No. 1 ST00BP00 is as follows:  
Location: 1,036.12 ft. from the East Line and 6,943.00 ft. from the North Line of Mississippi Canyon Block 252.

"Confidential Information"

Sheet 2 of 2



BP EXPLORATION AND PRODUCTION

Proposed Well Location OCS-G32306 MC 252 No. 1 ST00BP00  
Mississippi Canyon Area (OPD# NH16-10) Block 252 Offshore Federal - Louisiana

Plat prepared by: Brian D. Autio, RPLS BP IT&S GoM SPU

Scale 1" = 2000 ft

Date: 8 May 2009





# BP Gulf of Mexico - MMS APD Worksheet

## MASP - Frac Gradient Method

The frac pressure at the 22 Casing shoe is:

$$P @ \text{ shoe} = 8,000' \times 11.1 \text{ppg} \times 0.052 = 4,618 \text{ psi}$$

A column of 0.10 psi/ft gas yields:

$$P @ \text{ ML} = 4,618 - 0.10 \times 2,919' = 4,326 \text{ psi}$$

$$P @ \text{ surf} = 4,618 - 0.10 \times 8,000' = 3,818 \text{ psi}$$

## MASP - Bottom Hole Pressure Method

The bottom hole pressure at 9,900' TVD is:

$$P @ \text{ TD} = 9,900' \times 10.4 \text{ppg} \times 0.052 = 5,354 \text{ psi}$$

A column of 70% gas & 30% liquid back to surface gives:

$$P @ \text{ surf} = 5,354 - 0.7 \times 9,900' \times 0.10 \text{ psi/ft}$$

$$- 0.3 \times 9,900' \times 10.6 \text{ppg} \times 0.052 = 3,024 \text{ psi}$$

Using 70% gas and 30% liquid from ML to surface, the mudline pressure is:

$$P @ \text{ ML} = 3,024 + 0.7 \times 5,081' \times 0.10 \text{ psi/ft}$$

$$+ 0.3 \times 5,081' \times 10.6 \text{ppg} \times 0.052 = 4,220 \text{ psi}$$

## MASP (at surface)

MASP for 22 Casing = 3,024 psi

Worst Case MASP = 3,347 psi, rounded up to 3,400 psi

## Test Pressure

MASP at the wellhead (based on the liner) + 500 psi is:

$$P @ \text{ ML} = 5,051 + 500 = 5,551 \text{ psi}$$

The maximum test pressure with 8.6 ppg mud is:

$$P @ \text{ surf} = 5,551 - 5,081' \times 8.6 \text{ ppg} \times 0.052 = 3,279 \text{ psi}$$

At the casing shoe, external pressure is:

$$P_o @ \text{ shoe} = 8,000' \times 9.0 \text{ ppg} \times 0.052 = 3,744 \text{ psi}$$

The test pressure is limited to 70% of the 22" MYP:

$$P @ \text{ surf} = 0.7 \times 6,360 + 3,744 - 8,000' \times 8.6 \text{ppg} \times 0.052 = 4,618 \text{ psi}$$

The highest test pressure is 3,279 psi on 8.6 ppg mud, rounded up to 3,300 psi.

The frac pressure at the 18 shoe is:

$$P @ \text{ shoe} = 9,900' \times 12.3 \text{ppg} \times 0.052 = 6,332 \text{ psi}$$

A column of 0.15 psi/ft gas yields:

$$P @ \text{ ML} = 6,332 - 0.15 \times 4,819' = 5,609 \text{ psi}$$

$$P @ \text{ surf} = 6,332 - 0.15 \times 9,900' = 4,847 \text{ psi}$$

The bottom hole pressure at 12,500' TVD is:

$$P @ \text{ TD} = 12,500' \times 11.6 \text{ppg} \times 0.052 = 7,540 \text{ psi}$$

A column of 60% gas & 40% liquid back to surface gives:

$$P @ \text{ surf} = 7,540 - 0.6 \times 12,500' \times 0.15 \text{ psi/ft}$$

$$- 0.4 \times 12,500' \times 11.8 \text{ppg} \times 0.052 = 3,347 \text{ psi}$$

Using 60% gas and 40% liquid from ML to surface, the mudline pressure is:

$$P @ \text{ ML} = 3,347 + 0.6 \times 5,081' \times 0.15 \text{ psi/ft}$$

$$+ 0.4 \times 5,081' \times 11.8 \text{ppg} \times 0.052 = 5,051 \text{ psi}$$

MASP for 18 Liner = 3,347 psi

For the liner, MASP at the wellhead + 500 psi is:

$$P @ \text{ ML} = 5,051 + 500 = 5,551 \text{ psi}$$

The maximum test pressure with 10.6 ppg mud is:

$$P @ \text{ surf} = 5,551 - 5,081' \times 10.6 \text{ ppg} \times 0.052 = 2,751 \text{ psi}$$

At the liner shoe, external pressure is:

$$P_o @ \text{ shoe} = 9,900' \times 9.0 \text{ ppg} \times 0.052 = 4,633 \text{ psi}$$

The test pressure is limited to 70% of the 18" MYP:

$$P @ \text{ surf} = 0.7 \times 6,680 + 4,633 - 9,900' \times 10.6 \text{ppg} \times 0.052 = 3,852 \text{ psi}$$

Limiting the test pressure to 70% of the 22 Casing MYP at 7,600' yields:

$$P @ \text{ surf} = 0.7 \times 6,360 - 7,600' \times (10.6 \text{ppg} - 9.0 \text{ppg}) \times 0.052 = 3,820 \text{ psi}$$



# BP Gulf of Mexico - MMS APD Worksheet

## Minimum Design Factors

The burst design factor is calculated as follows:

$DF = MYP / \text{load}$ , where the load is the differential pressure at either the top of the string or at the shoe  
At the mudline, the internal pressure is the MASP at the wellhead

Internal pressure at 5,081' = 5,051 psi

External pressure at 5,081' =  $5,081' \times 8.6 \text{ ppg} \times 0.052 = 2,272 \text{ psi}$

$DF = 7,950 / (5,051 - 2,272) = 2.86$

At the 18 TOL, the internal pressure is the MASP at the wellhead + 2,519' of 60% gas and 40% mud

Internal pressure at 7,600' =  $5,051 \text{ psi} + 2,519' \times [0.4 \times 11.8 \text{ ppg} \times 0.052 + 0.6 \times 0.15 \text{ psi/ft}] = 5,896 \text{ psi}$

External pressure at 7,600' =  $7,600' \times 9.0 \text{ ppg} \times 0.052 = 3,557 \text{ psi}$

$DF = 6,360 / (5,896 - 3,557) = 2.72$

At the x-over, the internal pressure is the MASP at the wellhead + 80' of 70% gas and 30% mud

Internal pressure at 5,161' =  $5,051 \text{ psi} + 80' \times [0.3 \times 11.8 \text{ ppg} \times 0.052 + 0.7 \times 0.15 \text{ psi/ft}] = 5,074 \text{ psi}$

External pressure at 5,161' =  $5,161' \times 9.0 \text{ ppg} \times 0.052 = 2,415 \text{ psi}$

$DF = 6,360 / (5,074 - 2,415) = 2.39$

The minimum burst design factor = 2.39

The collapse design factor is calculated as follows:

$DF = \text{Collapse Rating} / \text{load}$ , where the load is defined by replacing the lightest internal mud weight with seawater down to the mudline

At the mudline, the internal pressure is 5,081' of 8.6 ppg sea water

Internal pressure at 5,081' =  $5,081' \times 8.6 \text{ ppg} \times 0.052 = 2,272 \text{ psi}$

External pressure at 5,081' =  $5,081' \times 9.5 \text{ ppg} \times 0.052 = 2,510 \text{ psi}$

The API collapse pressure is  $2,510 - 2,272 \times [1 - 2 / (22 / 1.25)] = 496 \text{ psi}$

$DF = 6,670 / 496 = 13.45$

At the shoe, the internal pressure is 5,081' of 8.6 ppg sea water + 2,919' of 8.6 ppg mud

Internal pressure at 8,000' =  $5,081' \times 8.6 \text{ ppg} \times 0.052 + 2,919' \times 8.6 \text{ ppg} \times 0.052 = 3,578 \text{ psi}$

External pressure at 8,000' =  $8,000' \times 9.5 \text{ ppg} \times 0.052 = 3,952 \text{ psi}$

The API collapse pressure is  $3,952 - 3,578 \times [1 - 2 / (22 / 1)] = 700 \text{ psi}$

$DF = 3,870 / 700 = 5.53$

At the x-over, the internal pressure is 5,081' of 8.6 ppg sea water + 80' of 8.6 ppg mud

Internal pressure at 5,161' =  $5,081' \times 8.6 \text{ ppg} \times 0.052 + 80' \times 8.6 \text{ ppg} \times 0.052 = 2,308 \text{ psi}$

External pressure at 5,161' =  $5,161' \times 9.5 \text{ ppg} \times 0.052 = 2,550 \text{ psi}$

The API collapse pressure is  $2,550 - 2,308 \times [1 - 2 / (22 / 1)] = 451 \text{ psi}$

$DF = 3,870 / 451 = 8.57$

The minimum collapse design factor is 5.53

The tension design factor is calculated as follows:

$DF = \text{Tension Rating} / \text{load}$ , where the load is the hanging weight of the string in mud plus 100 kips overpull

This simplified tension uses the TVD hanging weight and a buoyancy factor of  $(65.5 - 9.5) / 65.5 = 0.855$  for 9.5 ppg mud

Tension =  $(8,000' - 5,161') \times 224 \text{ ppg} \times 0.855 = 543.7 \text{ kips}$

$DF = 5,278.0 / (543.7 + 100 \text{ kips overpull}) = 8.20$

The tension design factor is 8.20



# BP Gulf of Mexico - MMS APD Worksheet

## MASP - Frac Gradient Method

The frac pressure at the 18 Liner shoe is:

$$P @ \text{ shoe} = 9,900' \times 12.3\text{ppg} \times 0.052 = 6,332 \text{ psi}$$

A column of 0.15 psi/ft gas yields:

$$P @ \text{ ML} = 6,332 - 0.15 \times 4,819' = 5,609 \text{ psi}$$

$$P @ \text{ surf} = 6,332 - 0.15 \times 9,900' = 4,847 \text{ psi}$$

## MASP - Bottom Hole Pressure Method

The bottom hole pressure at 12,500' TVD is:

$$P @ \text{ TD} = 12,500' \times 11.6\text{ppg} \times 0.052 = 7,540 \text{ psi}$$

A column of 60% gas & 40% liquid back to surface gives:

$$P @ \text{ surf} = 7,540 - 0.6 \times 12,500' \times 0.15 \text{ psi/ft}$$

$$- 0.4 \times 12,500' \times 11.8\text{ppg} \times 0.052 = 3,347 \text{ psi}$$

Using 60% gas and 40% liquid from ML to surface, the mudline pressure is:

$$P @ \text{ ML} = 3,347 + 0.6 \times 5,081' \times 0.15 \text{ psi/ft}$$

$$+ 0.4 \times 5,081' \times 11.8\text{ppg} \times 0.052 = 5,051 \text{ psi}$$

## MASP (at surface)

MASP for 18 Liner = 3,347 psi

Worst Case MASP = 3,347 psi, rounded up to 3,400 psi

## Test Pressure

MASP at the wellhead + 500 psi is:

$$P @ \text{ ML} = 5,051 + 500 = 5,551 \text{ psi}$$

The maximum test pressure with 10.6 ppg mud is:

$$P @ \text{ surf} = 5,551 - 5,081' \times 10.6 \text{ ppg} \times 0.052 = 2,751 \text{ psi}$$

At the casing shoe, external pressure is:

$$P_o @ \text{ shoe} = 9,900' \times 9.0 \text{ ppg} \times 0.052 = 4,633 \text{ psi}$$

The test pressure is limited to 70% of the 18" MIYP:

$$P @ \text{ surf} = 0.7 \times 6,680 + 4,633 - 9,900' \times 10.6\text{ppg} \times 0.052 = 3,852 \text{ psi}$$

The test pressure is also limited by the 22 Casing at 7,600'

$$P @ \text{ surf} = 0.7 \times 6,360 - 7,600' \times (10.6\text{ppg} - 9.0\text{ppg}) \times 0.052 = 3,820 \text{ psi}$$

The highest test pressure is 2,751 psi on 10.6 ppg mud, rounded up to 2,800 psi.



# BP Gulf of Mexico - MMS APD Worksheet

## Minimum Design Factors

The burst design factor is calculated as follows:

$DF = MYP / \text{load}$ , where the load is the differential pressure at either the top of the string or at the shoe

At the TOL, the internal pressure is the MASP at the wellhead + 2,519' of 60% gas / 40% mud

$$\text{Internal pressure at } 7,600' = 5,051 \text{ psi} + 2,519' \times [0.4 \times 11.8 \text{ ppg} \times 0.052 + 0.6 \times 0.15 \text{ psi/ft}] = 5,896 \text{ psi}$$

$$\text{External pressure at } 7,600' = 7,600' \times 9.0 \text{ ppg} \times 0.052 = 3,557 \text{ psi}$$

$$DF = 6,680 / (5,896 - 3,557) = 2.86$$

At the shoe, the internal pressure is the MASP at the wellhead + 4,819' of 60% gas and 40% mud

$$\text{Internal pressure at } 9,900' = 5,051 \text{ psi} + 4,819' \times [0.4 \times 11.8 \text{ ppg} \times 0.052 + 0.6 \times 0.15 \text{ psi/ft}] = 6,668 \text{ psi}$$

$$\text{External pressure at } 9,900' = 9,900' \times 9.0 \text{ ppg} \times 0.052 = 4,633 \text{ psi}$$

$$DF = 6,680 / (6,668 - 4,633) = 3.28$$

The minimum burst design factor = 2.86

The collapse design factor is calculated as follows:

$DF = \text{Collapse Rating} / \text{load}$ , where the load is defined by replacing the lightest internal mud weight with seawater down to the mudline

At the TOL, the internal pressure is 5,081' of 8.6 ppg sea water + 2,519' of 10.6 ppg mud

$$\text{Internal pressure at } 7,600' = 5,081' \times 8.6 \text{ ppg} \times 0.052 + 2,519' \times 10.6 \text{ ppg} \times 0.052 = 3,661 \text{ psi}$$

$$\text{External pressure at } 7,600' = 7,600' \times 10.6 \text{ ppg} \times 0.052 = 4,189 \text{ psi}$$

$$\text{The API collapse pressure is } 4,189 - 3,661 \times [1 - 2 / (18 / 0.625)] = 783 \text{ psi}$$

$$DF = 2,110 / 783 = 2.70$$

At the shoe, the internal pressure is 5,081' of 8.6 ppg sea water + 4,819' of 10.6 ppg mud

$$\text{Internal pressure at } 9,900' = 5,081' \times 8.6 \text{ ppg} \times 0.052 + 4,819' \times 10.6 \text{ ppg} \times 0.052 = 4,928 \text{ psi}$$

$$\text{External pressure at } 9,900' = 9,900' \times 10.6 \text{ ppg} \times 0.052 = 5,457 \text{ psi}$$

$$\text{The API collapse pressure is } 5,457 - 4,928 \times [1 - 2 / (18 / 0.625)] = 871 \text{ psi}$$

$$DF = 2,110 / 871 = 2.42$$

The minimum collapse design factor = 2.42

The tension design factor is calculated as follows:

$DF = \text{Tension Rating} / \text{load}$ , where the load is the hanging weight of the string in mud plus 100 kips overpull

This simplified tension uses the TVD hanging weight and a buoyancy factor of (65.5 - 10.6) / 65.5 = 0.838 for 10.6 ppg mud

$$\text{Tension} = (9,900' - 7,600') \times 117 \text{ ppf} \times 0.838 = 225.6 \text{ kips}$$

$$DF = 2,331.0 / (225.6 + 100 \text{ kips overpull}) = 7.16$$

The tension design factor is 7.16



# BP Gulf of Mexico - MMS APD Worksheet

## MASP - Frac Gradient Method

The frac pressure at the 16 Casing shoe is:

$$P @ \text{ shoe} = 12,500' \times 13.6\text{ppg} \times 0.052 = 8,840 \text{ psi}$$

A column of 0.15 psi/ft gas yields:

$$P @ \text{ ML} = 8,840 - 0.15 \times 7,419' = 7,727 \text{ psi}$$

$$P @ \text{ surf} = 8,840 - 0.15 \times 12,500' = 6,965 \text{ psi}$$

## MASP - Bottom Hole Pressure Method

The bottom hole pressure at 15,300' TVD is:

$$P @ \text{ TD} = 15,300' \times 12.9\text{ppg} \times 0.052 = 10,263 \text{ psi}$$

A column of 50% gas & 50% liquid back to surface gives:

$$P @ \text{ surf} = 10,263 - 0.5 \times 15,300' \times 0.15 \text{ psi/ft}$$

$$- 0.5 \times 15,300' \times 13.1\text{ppg} \times 0.052 = 3,905 \text{ psi}$$

Using 50% gas and 50% liquid from ML to surface, the mudline pressure is:

$$P @ \text{ ML} = 3,905 + 0.5 \times 5,081' \times 0.15 \text{ psi/ft}$$

$$+ 0.5 \times 5,081' \times 13.1\text{ppg} \times 0.052 = 6,016 \text{ psi}$$

## MASP (at surface)

MASP for 16 Casing = 3,905 psi

Worst Case MASP = 5,733 psi, rounded up to 5,800 psi

## Test Pressure

MASP at the wellhead (based on the liner) + 500 psi is:

$$P @ \text{ ML} = 7,990 + 500 = 8,490 \text{ psi}$$

The maximum test pressure with 11.8 ppg mud is:

$$P @ \text{ surf} = 8,490 - 5,081' \times 11.8 \text{ ppg} \times 0.052 = 5,372 \text{ psi}$$

At the casing shoe, external pressure is:

$$P_o @ \text{ shoe} = 12,500' \times 9.0 \text{ ppg} \times 0.052 = 5,850 \text{ psi}$$

The test pressure is limited to 70% of the 16" MYP:

$$P @ \text{ surf} = 0.7 \times 6,660 + 5,850 - 12,500' \times 11.8\text{ppg} \times 0.052 = 2,842 \text{ psi}$$

The highest test pressure is 3,579 psi on 13.1 ppg mud, rounded up to 3,600 psi.

The frac pressure at the 13.625 shoe is:

$$P @ \text{ shoe} = 15,300' \times 14.7\text{ppg} \times 0.052 = 11,695 \text{ psi}$$

A column of 0.15 psi/ft gas yields:

$$P @ \text{ ML} = 11,695 - 0.15 \times 10,219' = 10,162 \text{ psi}$$

$$P @ \text{ surf} = 11,695 - 0.15 \times 15,300' = 9,400 \text{ psi}$$

The bottom hole pressure at 20,200' TVD is:

$$P @ \text{ TD} = 20,200' \times 14.0\text{ppg} \times 0.052 = 14,706 \text{ psi}$$

A column of 50% gas & 50% liquid back to surface gives:

$$P @ \text{ surf} = 14,706 - 0.5 \times 20,200' \times 0.15 \text{ psi/ft}$$

$$- 0.5 \times 20,200' \times 14.2\text{ppg} \times 0.052 = 5,733 \text{ psi}$$

Using 50% gas and 50% liquid from ML to surface, the mudline pressure is:

$$P @ \text{ ML} = 5,733 + 0.5 \times 5,081' \times 0.15 \text{ psi/ft}$$

$$+ 0.5 \times 5,081' \times 14.2\text{ppg} \times 0.052 = 7,990 \text{ psi}$$

MASP for 13.625 Liner = 5,733 psi

For the liner, MASP at the wellhead + 500 psi is:

$$P @ \text{ ML} = 7,990 + 500 = 8,490 \text{ psi}$$

The maximum test pressure with 13.1 ppg mud is:

$$P @ \text{ surf} = 8,490 - 5,081' \times 13.1 \text{ ppg} \times 0.052 = 5,029 \text{ psi}$$

At the liner shoe, external pressure is:

$$P_o @ \text{ shoe} = 15,300' \times 9.0 \text{ ppg} \times 0.052 = 7,160 \text{ psi}$$

The test pressure is limited to 70% of the 13.625" MYP:

$$P @ \text{ surf} = 0.7 \times 10,030 + 7,160 - 15,300' \times 13.1\text{ppg} \times 0.052 = 3,759 \text{ psi}$$

Limiting the test pressure to 70% of the 16 Casing MYP at 5,081' yields:

$$P @ \text{ surf} = 0.7 \times 6,660 - 5,081' \times (13.1\text{ppg} - 9.0\text{ppg}) \times 0.052 = 3,579 \text{ psi}$$



# BP Gulf of Mexico - MMS APD Worksheet

## Minimum Design Factors

The burst design factor is calculated as follows:

$DF = MYP / \text{load}$ , where the load is the differential pressure at either the top of the string or at the shoe

At the mudline, the internal pressure is the MASP at the wellhead

Internal pressure at 5,081' = 7,990 psi

External pressure at 5,081' = 5,081' x 8.6 ppg x 0.052 = 2,272 psi

$DF = 6,660 / (7,990 - 2,272) = 1.16$

At the 13,625 TOC, the internal pressure is the MASP at the wellhead + 7,119' of 50% gas and 50% mud

Internal pressure at 12,200' = 7,990 psi + 7,119' x [0.5 x 14.2 ppg x 0.052 + 0.5 x 0.15 psi/ft] = 11,152 psi

External pressure at 12,200' = 12,200' x 9.0 ppg x 0.052 = 5,710 psi

$DF = 6,660 / (11,152 - 5,710) = 1.22$

The minimum burst design factor = 1.16

The collapse design factor is calculated as follows:

$DF = \text{Collapse Rating} / \text{load}$ , where the load is defined by replacing the lightest internal mud weight with seawater down to the mudline

At the mudline, the internal pressure is 5,081' of 8.6 ppg sea water

Internal pressure at 5,081' = 5,081' x 8.6 ppg x 0.052 = 2,272 psi

External pressure at 5,081' = 5,081' x 11.8 ppg x 0.052 = 3,118 psi

The API collapse pressure is 3,118 - 2,272 x [1 - 2 / (16 / 0.575)] = 1,009 psi

$DF = 2,340 / 1,009 = 2.32$

At the shoe, the internal pressure is 5,081' of 8.6 ppg sea water + 7,419' of 11.8 ppg mud

Internal pressure at 12,500' = 5,081' x 8.6 ppg x 0.052 + 7,419' x 11.8 ppg x 0.052 = 6,825 psi

External pressure at 12,500' = 12,500' x 11.8 ppg x 0.052 = 7,670 psi

The API collapse pressure is 7,670 - 6,825 x [1 - 2 / (16 / 0.575)] = 1,336 psi

$DF = 2,340 / 1,336 = 1.75$

The minimum collapse design factor = 1.75

The tension design factor is calculated as follows:

$DF = \text{Tension Rating} / \text{load}$ , where the load is the hanging weight of the string in mud plus 100 kips overpull

This simplified tension uses the TVD hanging weight and a buoyancy factor of (65.5 - 11.8) / 65.5 = 0.820 for 11.8 ppg mud

Tension = (12,500' - 5,081') x 97 ppf x 0.820 = 590.0 kips

$DF = 1,916.0 / (590.0 + 100 \text{ kips overpull}) = 2.78$

The tension design factor is 2.78



# BP Gulf of Mexico - MMS APD Worksheet

## MASP - Frac Gradient Method

The frac pressure at the 13.625 Liner shoe is:

$$P @ \text{ shoe} = 15,300' \times 14.7 \text{ ppg} \times 0.052 = 11,695 \text{ psi}$$

A column of 0.15 psi/ft gas yields:

$$P @ \text{ ML} = 11,695 - 0.15 \times 10,219' = 10,162 \text{ psi}$$

$$P @ \text{ surf} = 11,695 - 0.15 \times 15,300' = 9,400 \text{ psi}$$

## MASP - Bottom Hole Pressure Method

The bottom hole pressure at 20,200' TVD is:

$$P @ \text{ TD} = 20,200' \times 14.0 \text{ ppg} \times 0.052 = 14,706 \text{ psi}$$

A column of 50% gas & 50% liquid back to surface gives:

$$P @ \text{ surf} = 14,706 - 0.5 \times 20,200' \times 0.15 \text{ psi/ft}$$

$$- 0.5 \times 20,200' \times 14.2 \text{ ppg} \times 0.052 = 5,733 \text{ psi}$$

Using 50% gas and 50% liquid from ML to surface, the mudline pressure is:

$$P @ \text{ ML} = 5,733 + 0.5 \times 5,081' \times 0.15 \text{ psi/ft}$$

$$+ 0.5 \times 5,081' \times 14.2 \text{ ppg} \times 0.052 = 7,990 \text{ psi}$$

## MASP (at surface)

MASP for 13.625 Liner = 5,733 psi

Worst Case MASP = 5,733 psi, rounded up to 5,800 psi

## Test Pressure

MASP at the wellhead + 500 psi is:

$$P @ \text{ ML} = 7,990 + 500 = 8,490 \text{ psi}$$

The maximum test pressure with 13.1 ppg mud is:

$$P @ \text{ surf} = 8,490 - 5,081' \times 13.1 \text{ ppg} \times 0.052 = 5,029 \text{ psi}$$

At the casing shoe, external pressure is:

$$P_o @ \text{ shoe} = 15,300' \times 9.0 \text{ ppg} \times 0.052 = 7,160 \text{ psi}$$

The test pressure is limited to 70% of the 13.625" MYP:

$$P @ \text{ surf} = 0.7 \times 10,030 + 7,160 - 15,300' \times 13.1 \text{ ppg} \times 0.052 = 3,759 \text{ psi}$$

The test pressure is also limited by the 16" Casing at 12,200'

$$P @ \text{ surf} = 0.7 \times 6,660 - 12,200' \times (13.1 \text{ ppg} - 9.0 \text{ ppg}) \times 0.052 = 2,061 \text{ psi}$$

The highest test pressure is 2,061 psi on 13.1 ppg mud, rounded up to 2,100 psi.



# BP Gulf of Mexico - MMS APD Worksheet

## Minimum Design Factors

The burst design factor is calculated as follows:

$DF = MYP / \text{load}$ , where the load is the differential pressure at either the top of the string or at the shoe

At the *TOL*, the internal pressure is the *MASP* at the wellhead + 7,119' of 50% gas / 50% mud

$$\text{Internal pressure at } 12,200' = 7,990 \text{ psi} + 7,119' \times [0.5 \times 14.2 \text{ ppg} \times 0.052 + 0.5 \times 0.15 \text{ psi/ft}] = 11,152 \text{ psi}$$

$$\text{External pressure at } 12,200' = 12,200' \times 9.0 \text{ ppg} \times 0.052 = 5,710 \text{ psi}$$

$$DF = 10,030 / (11,152 - 5,710) = 1.84$$

At the shoe, the internal pressure is the *MASP* at the wellhead + 10,219' of 50% gas and 50% mud

$$\text{Internal pressure at } 15,300' = 7,990 \text{ psi} + 10,219' \times [0.5 \times 14.2 \text{ ppg} \times 0.052 + 0.5 \times 0.15 \text{ psi/ft}] = 12,529 \text{ psi}$$

$$\text{External pressure at } 15,300' = 15,300' \times 9.0 \text{ ppg} \times 0.052 = 7,160 \text{ psi}$$

$$DF = 10,030 / (12,529 - 7,160) = 1.87$$

The minimum burst design factor = 1.84

The collapse design factor is calculated as follows:

$DF = \text{Collapse Rating} / \text{load}$ , where the load is defined by replacing the lightest internal mud weight with seawater down to the mudline

At the *TOL*, the internal pressure is 5,081' of 8.6 ppg sea water + 7,119' of 13.1 ppg mud

$$\text{Internal pressure at } 12,200' = 5,081' \times 8.6 \text{ ppg} \times 0.052 + 7,119' \times 13.1 \text{ ppg} \times 0.052 = 7,122 \text{ psi}$$

$$\text{External pressure at } 12,200' = 12,200' \times 13.1 \text{ ppg} \times 0.052 = 8,311 \text{ psi}$$

$$\text{The API collapse pressure is } 8,311 - 7,122 \times [1 - 2 / (13.625 / 0.625)] = 1,842 \text{ psi}$$

$$DF = 4,800 / 1,842 = 2.61$$

At the shoe, the internal pressure is 5,081' of 8.6 ppg sea water + 10,219' of 13.1 ppg mud

$$\text{Internal pressure at } 15,300' = 5,081' \times 8.6 \text{ ppg} \times 0.052 + 10,219' \times 13.1 \text{ ppg} \times 0.052 = 9,233 \text{ psi}$$

$$\text{External pressure at } 15,300' = 15,300' \times 13.1 \text{ ppg} \times 0.052 = 10,422 \text{ psi}$$

$$\text{The API collapse pressure is } 10,422 - 9,233 \times [1 - 2 / (13.625 / 0.625)] = 2,036 \text{ psi}$$

$$DF = 4,800 / 2,036 = 2.36$$

The minimum collapse design factor = 2.36

The tension design factor is calculated as follows:

$DF = \text{Tension Rating} / \text{load}$ , where the load is the hanging weight of the string in mud plus 100 kips overpull

This simplified tension uses the TVD hanging weight and a buoyancy factor of (65.5 - 13.1) / 65.5 = 0.800 for 13.1 ppg mud

$$\text{Tension} = (15,300' - 12,200') \times 88.7 \text{ ppi} \times 0.800 = 220.0 \text{ kips}$$

$$DF = 2,393.0 / (220.0 + 100 \text{ kips overpull}) = 7.48$$

The tension design factor is 7.48



**MC 252 #1 - Macondo Prospect**  
**MMS APD Attachment - PP/MW/FG**

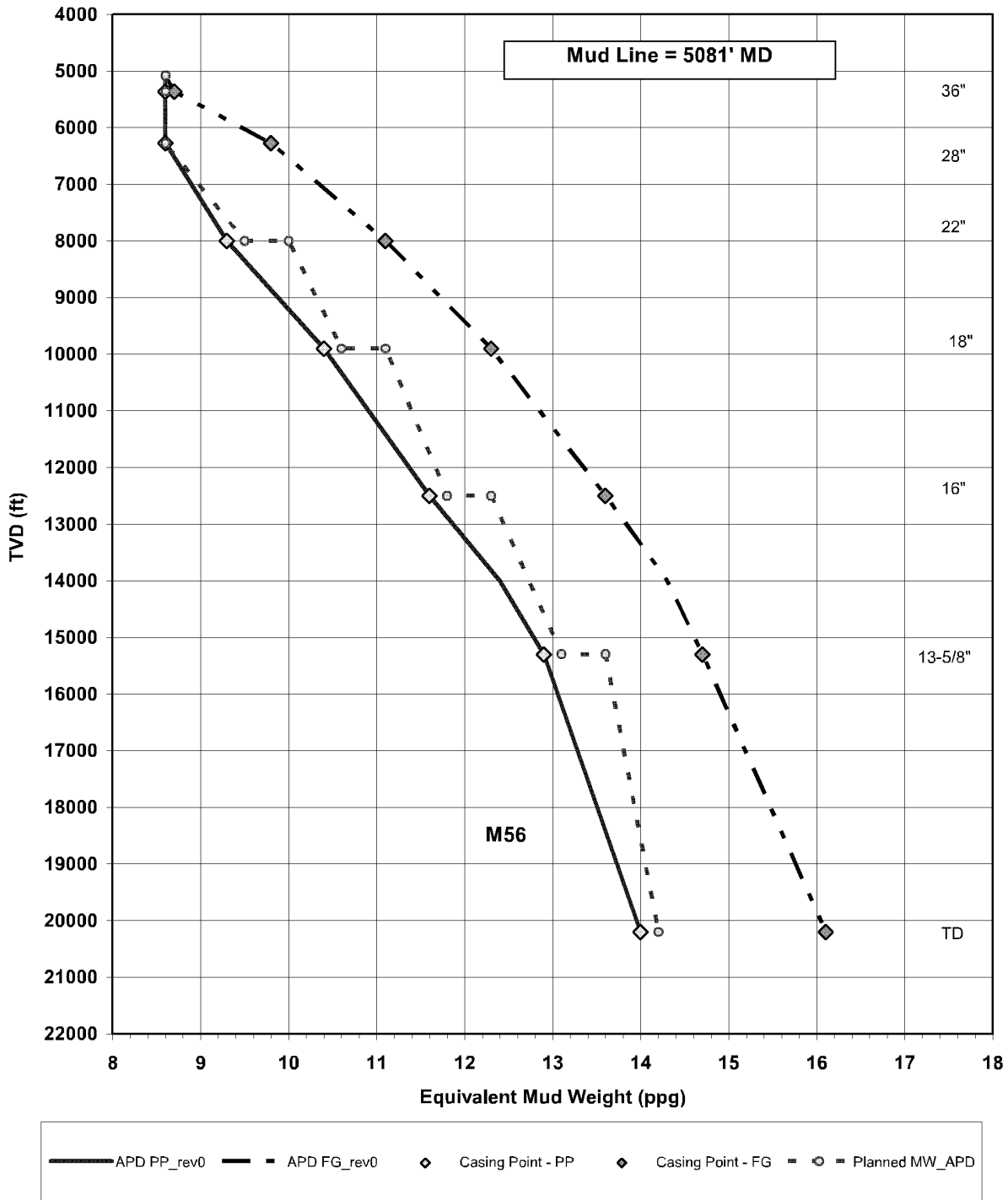

MC 252 #1  
OCS-G-32306  
Attachment 2

Mark Hafle  
5/11/09

## MMS Application for Permit to Drill

---

### Departures to Code of Federal Regulations (23-Feb-03 Edition)

- 250.423 (b) The conductor casing (28") will not be tested to 200 psi as the subsequent open hole section will be drilled riserless.
- 250.433(b) Partial closing of the diverter sealing element shall be considered to be an actuation test. Full closure actuation will be conducted in conjunction with regular scheduled BOP testing. The vent lines will not be flow tested and the system will not be pressure tested per the subject regulation.
- 250.445(g) A safety valve will not be on the rig floor for the casing being run unless the casing string length results in the casing being across the blind/shear rams prior to crossing over to the drill pipe running string.
- 250.447(b) The 14-day BOP pressure test is not required for blind shear rams. The blind shear rams and the wellhead connector will be tested to the casing pressure tests as specified in the APD during casing tests such that code requirement of 250.449(e) is met.
- 250.447(c) The BOP's will be pressure tested every 14 days. The BOP test before drilling out each casing string and/or liner shall not be expressly required, except that the 14-day pressure test must be valid. This applies to the following casing strings:
- 18" Liner
  - 16"
  - 13 5/8" Liner
  - contingency liners
- 250.448 (b & c) The subsea BOPs will *not* be pressure tested to 15K psi rated working pressure, and the annular will *not be* tested to 70% of its rated working pressure, on the test stump, or after installation. We propose that the single ram type BOPs shall be stump-tested to 10,000 psi and the annular-type BOPs shall be stump-tested to 5,000 psi. Thereafter, test pressures will be per the APD.
- The blind/shear rams will not be pressure tested to their rated working pressure upon installation or during subsequent tests. The blind/shear rams will be tested to the casing test pressures as specified in the APD.
- The upper inner and outer annular bleed valves will *not* be pressure tested to their rated working pressure. A pressure test of the upper inner and outer bleed valves will be performed against the annular BOP to the annular test pressure specified in the APD.

- 250.449 (f) Request not to test on 6<sup>5</sup>/<sub>8</sub>" casing landing string during BOP tests. During drilling operations 6<sup>5</sup>/<sub>8</sub>" drill pipe will be used above the BOP stack (it will never go into or below the BOP stack). The remainder of the string will be made up of 5<sup>1</sup>/<sub>2</sub>" drill pipe (From the BOP stack down). However to land the heavy 22" and 16" casing strings, a 6<sup>5</sup>/<sub>8</sub>" drill pipe landing string will be used. Once the casing is landed and cemented, the 6<sup>5</sup>/<sub>8</sub>" drill pipe will be across the BOP stack (for approximately 12 hours). There will be no drilling ahead with the 6<sup>5</sup>/<sub>8</sub>" drill pipe in or below the BOP stack. Both 5<sup>1</sup>/<sub>2</sub>" drill pipe and 6<sup>5</sup>/<sub>8</sub>" drill pipe will be tested during the stump test, prior to running the BOP stack.
- 250.449 (f) Variable bore-pipe rams will be pressure tested against largest and smallest sizes of pipe that will be across the stack, excluding drill collars, HWDP, and bottom-hole tools.
- The annular BOP will only be tested to the smallest OD drill pipe when a tapered string is in use.
- 250.449(h) Request to delay or omit 7-day function test of Blind/Shear and casing shear rams, when function test is due and the drill string is across the stack. The maximum time between function tests shall not exceed 14 days, unless authorized by the MMS district office on a case by case basis.
- 250.461 (a)(2) In the event a directional MWD is run, a multi-shot (or single-shot) survey shall not be required at casing points or TD.

MC 252 #001 is a straight hole.

DATE  
 OPERATOR B P  
 LOCATION MC252  
 WELL NAME Macondo  
 WATER DEPTH 4992 Ft  
 RKB to Waterline 89  
 RKB TO MUDLINE 5081 Ft  
 RKB TO WELLHEAD 5071 Ft  
 Ht ML to WELLHEAD 10 Ft

**Marianas**

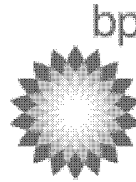

**Drill & Comp**

WELLHEAD TYPE Vetco  
 CONNECTOR TYPE H4 E x F

Ram Cavity Elev (Inches)  
 Spaceouts (Inches)  
 Elev. From BOP Conn face (inches)

Drilling Completion

Elev. From RKB (ft)  
 W/O THS with THS

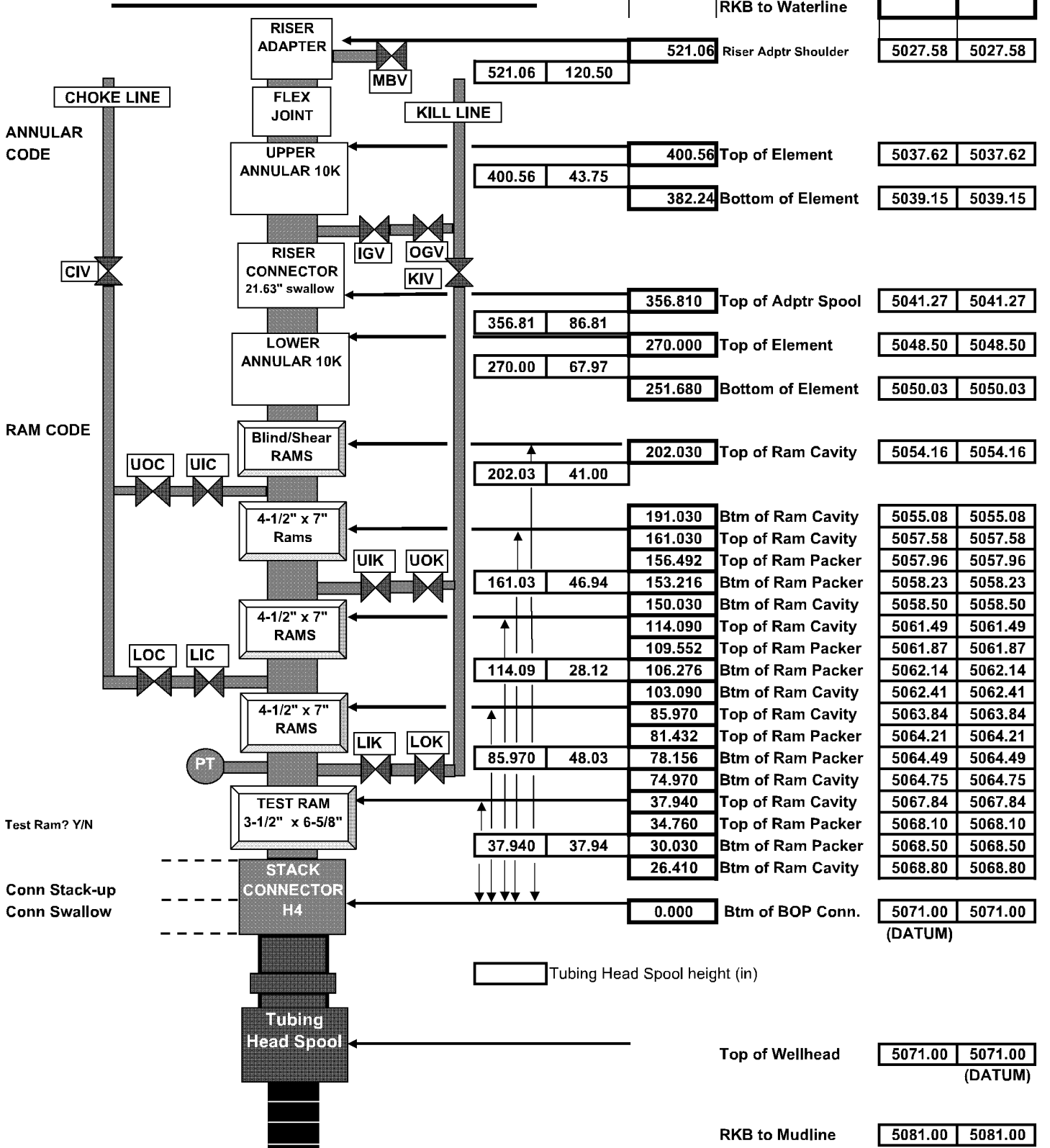

▭ Tubing Head Spool height (in)

**Douglas, Scherie D**

---

**From:** Labiche, Lance [Lance.Labiche@mms.gov]  
**Sent:** Wednesday, May 13, 2009 9:07 AM  
**To:** Douglas, Scherie D  
**Cc:** Powers, Jane; Patton, Frank; Trocquet, David; Labiche, Lance  
**Subject:** Mooring approval for BP at MC 252 - Marianas

Scherie,

We have reviewed the mooring application submitted for the *Transocean Marianas* at Mississippi Canyon Block 252. MMS will allow the *Transocean Marianas* to be on the MC 252 location through August 15, 2009, with the mooring system proposed in Intermoor's mooring report dated April 29, 2009 and Delmar's mooring risk assessment dated April 29, 2009 (#4128-RA-0). This approval is conditional on the following:

- All of the mooring components have current inspection records and there are no documented defects/damages to any of the equipment.
- Anchors will be installed according to the installation plan.
- BP will contact the MMS New Orleans Drilling engineer (Frank Patton) on August 1, 2009, to discuss the progress of the well and the projected schedule. If, at the time of this progress report, it looks as though you will not meet the August 15, 2009 move-off date, you will be directed to secure the well and move off location. You will also provide to him how long it will take to secure the well and move off location, including the name of the vessels that will be conducting this work. [Note: If BP believes that there is not a sufficient weather window to safely move the rig off of this location and on to the next location, you should provide sufficient information to the MMS New Orleans Drilling Engineer and discuss this with him. MMS does not want a moored rig without all of its mooring system to be on location during a tropical storm event.]
- A detailed configuration listing all of the mooring equipment as installed in the mooring lines must be submitted to either Lance Labiche or Jane Powers once the rig is moored on location.
- If the mooring system sustains any damage during the 2009 hurricane season you must recover the damaged components and conduct a detailed investigation to determine the failure mechanism/mode of the damaged components.
- Please attach this email along with the report and risk assessment to your Ewell submittal.

Thanks,

**Lance Labiche**  
*Petroleum Engineer*  
MMS, Office of Safety Management  
Phone: (504)736-2433  
lance.labiche@mms.gov

5/13/2009

CONFIDENTIAL



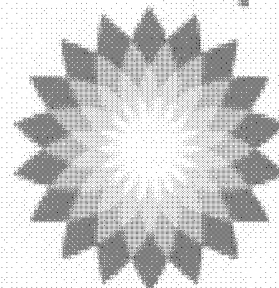

TRN-MDL-00672335

bp

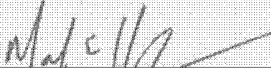

# MC 252 #1 Macondo Prospect

## Drilling Program September 2009 Final

Prepared by:	Brian Morel	 9-22-09 Drilling Engineer
Reviewed by:	Mark Haffe	 9/22/09 Senior Drilling Engineer
Reviewed by:	Trent Fleece	 9-22-09 Ops Drilling Engineer
Approved:	David Sims	 9-22-09 Drilling Engineer Team Lead
Approved:	George Gray	 23-Sept-09 Well Team Leader
Approved:	Ian Little	 24/Sept/09 Wells Manager

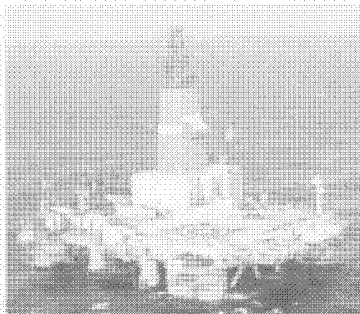

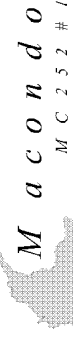

**MC 252 #1, OCS-G 32306 – Macondo Prospect**

**Rev. 0, Sept 2009**

***Drilling Program***

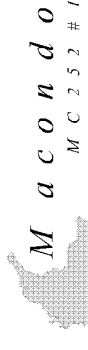
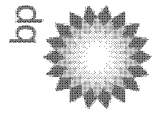

**MC 252 #1, OCS-G 32306 – Macondo Prospect**

**Rev. 0, Sept 2009**

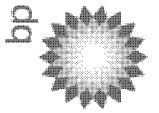

***Drilling Program***



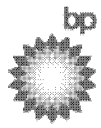

## Table of Contents

<b>1</b>	<b>WELL INFORMATION</b> .....	<b>2</b>
1.1	Well Objectives.....	2
1.2	Basic Well Data .....	2
1.3	Program Specifics.....	3
1.3.1	Casing Program .....	3
1.3.2	Wellhead Program.....	3
1.3.3	Mud Program.....	3
1.3.4	Wellbore Surveying Program .....	4
1.3.5	Open Hole Wireline Logging Program .....	4
1.3.6	Mud Logging.....	4
1.3.7	Coring Program .....	4
1.4	MMS Notes .....	5
1.5	Location Map .....	6
1.6	Location Plat.....	7
1.7	Drilling Summary .....	8
1.8	Wellbore Schematic .....	10
1.9	Days vs Depth Curve .....	11
1.10	Cost vs Depth Curve.....	12
1.11	Mud Program .....	13

	<b>GoM Exploration Wells</b> <b>MC 252 #1 – Macondo Prospect</b> <b>Well Information</b>	
---	--	---



## 1 Well Information

### 1.1 Well Objectives

- Drill and evaluate the Macondo prospect in MC 252 #1. Primary target interval expected at ~18,400', with the secondary target being below the primary target interval (as prescribed in the PDDP).
- If well results are positive, acquire sufficient information to plan an efficient appraisal program. If negative, acquire information to determine reasons for failure.
- Deliver drilling performance targets established in the AFE.
- Successfully evaluate any commercial hydrocarbon interval discovered.
- Incur (0) MMS "Incidents of Non-Compliance" while conducting operations on this federal lease.
- Our HSSE objective is Zero Incidents, no harm to people, environment or equipment. We will accomplish this by:
  - Fully implementing Transocean's Health & Safety Management System on the Marianas
  - Supervision on deck.
  - Living the Marianas Safe Way Forward Plan
  - Focus on: Risk Assessment, Planning, Lifting, DROPS and preventing Hand injuries.
  - Use of the THINK Planning Process and the START Observation and Monitoring Process.

### 1.2 Basic Well Data

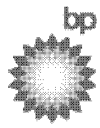
Well Data	
Operator	BP
Working Interest Partner	None at this time (A partner is expected)
Well Name	OCS-G 32306, Mississippi Canyon 252 #1
Common Name	Macondo
Water Depth	4992
MSL - RT	89' (Transocean Marianas)
RT – ML	5081'
Planned Total Depth	19,650'
Authorized Total Depth	19,650'
Authorized Cost	\$96.16MM
AFE number (SAP)	X2-000X8
Regulatory Agency	MMS – New Orleans District
API number	608174116900
Surface Location Tolerance	50'
BH Target Hard Lines	125' Radius

	<b>GoM Exploration Wells</b> <b>MC 252 #1 – Macondo Prospect</b> <b>Well Information</b>	
---	--	---

Location	X Coordinate	Y Coordinate	Latitude	Longitude
Surface	1,202,803.88	10,431,617.00	28° 44' 17.277" N	88° 21' 57.340" W
Bottom Hole	1,202,803.88	10,431,617.00	28° 44' 17.277" N	88° 21' 57.340" W

### 1.3 Program Specifics

#### 1.3.1 Casing Program



Casing Size	Setting MD	Setting TVD
36 in.	5361	5361
28 in.	6275	6275
22 in.	8000	8000
18 in.	9900	9900
16 in.	12500	12500
13-5/8 in.	15300	15300
11-7/8 in.	Contingency	Contingency
9-7/8 in.	19,650	19,650

#### 1.3.2 Wellhead Program

Vendor	Equipment
Dril-Quip	SS-15 ES Big Bore II
	36 in. Low Pressure Housing, Annular Outlet Spool with 6 Annular Shut-Off Valves
	Two (2) Slope Indicator Supports
	28 in. Supplemental Hanger
	18-3/4 in. High Pressure Housing – with HD-H4, 27" O.D. wellhead connector
	18 in. and 16 in. Supplemental Adapters, Hangers, and Seal Assemblies
	9-7/8 in. 2 <sup>nd</sup> position hanger with 1 <sup>st</sup> position dummy hanger

#### 1.3.3 Mud Program

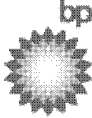
Casing Interval	Mud Type	Density
28 in.	SW	8.6 (surface)
22 in.	SW / WBM	8.6 – 12.0 ppg PAD (surface)
18 in.	SOBM	10.0 – 10.6 ppg (surface)
16 in.	SOBM	10.6 – 11.8 ppg (surface)
13-5/8 in.	SOBM	11.8 – 13.1 ppg (surface)
9-7/8 in. or OH	SOBM	13.1 – 14.6 ppg (surface)

	<b>GoM Exploration Wells</b> <b>MC 252 #1 – Macondo Prospect</b> <b>Well Information</b>	
---	--	---

**1.3.4 Wellbore Surveying Program**

Casing Interval	Survey Type	Frequency
28 in.	MWD	Every stand
22 in.	MWD	Every stand
16 in.	MWD	Every 500 ft minimum (to be advised)
13-5/8 in.	MWD	Every 500 ft minimum (to be advised)
9-7/8 in. or OH	MWD	Every 500 ft minimum (to be advised)

**Note: Survey frequency may be increased if inclination becomes problematic.**

**1.3.5 Open Hole Wireline Logging Program**



All wireline logs are **optional** runs. Please refer to the PDDP for logging decision guidelines.

**1.3.6 Mud Logging**

Mud logging (recording drilling parameters) will begin at the mud line. (For the full sampling and shipping requirements, see the PDDP.) Sample collection will begin after 22 in. casing is set and riser is run.

**1.3.7 Coring Program**

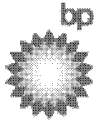
No cores are planned.

	<b>GoM Exploration Wells</b> <b>MC 252 #1 – Macondo Prospect</b> <b>Well Information</b>	
---	--	---

#### 1.4 MMS Notes

The Macondo Exploration Plan was approved by the MMS on April 6, 2009 with the following comments:

- Exercise caution while drilling due to indications of shallow gas and possible water flow.
- Hydrogen sulfide (H2S) classification, the area in which the proposed drilling operations are to be conducted is hereby classified, in accordance with 30 CFR 250.490(c), as "H2S absent."

The Macondo APD was submitted on May 12, 2009 and was approved May 26, 2009. Exercise caution while drilling due to indications of shallow gas and possible water flow.

The APD was approved with the following cautions / conditions:

- Please use caution while drilling because of possible shallow gas at 4370 feet to 4820 feet (BML).
- Please use caution while drilling because of a moderate potential shallow water flow at 1832 feet to 1944 feet, 3200 feet to 3367 feet 3760 feet to 3960 feet and 437- feet to 4600 feet BML.
- Please be reminded that an APM should be submitted with a final surveyed surface location plat (in NAD 83), KB, and water depth as soon as they are determined.
- If the water depth is greater than 800 meters (2,624 feet) and you plan to leave the wellhead on the seafloor after plugging and abandoning of this well, you are required to obtain MMS approval as soon as possible and no later than 5 work days prior to the start of plugging operations for the well so that MMS will have time to get concurrence from the Navy. Your request should contain the following information: Lat. and Long. coordinates, water depth, wellhead height, completion guide base height, and aerial extent. If the water depth is greater than 1,666 meters (5000 feet), then concurrence from the Navy is not required. The approval of waiver to leave a wellhead on the sea floor in water depth less than 800 meters (2,624 feet) will be limited to request that pose a mechanical problem or a safety concern, such as diver safety when excavating around the wellhead on the seafloor. The waiver must be approved by the District Manager and concurrence from the Navy must be obtained.

**Note:** For any clarification requirements, contact Scherie Douglas at 281-366-6843.

Please read and post the APD in the WSL office, as it is the governing document for these well operations and any deviation from the printed details will need to be approved by the MMS before continuing operations.

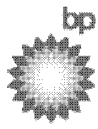

# GoM Exploration Wells

## MC 252 #1 – Macondo Prospect

### Well Information



### 1.5 Location Map

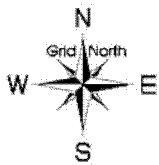
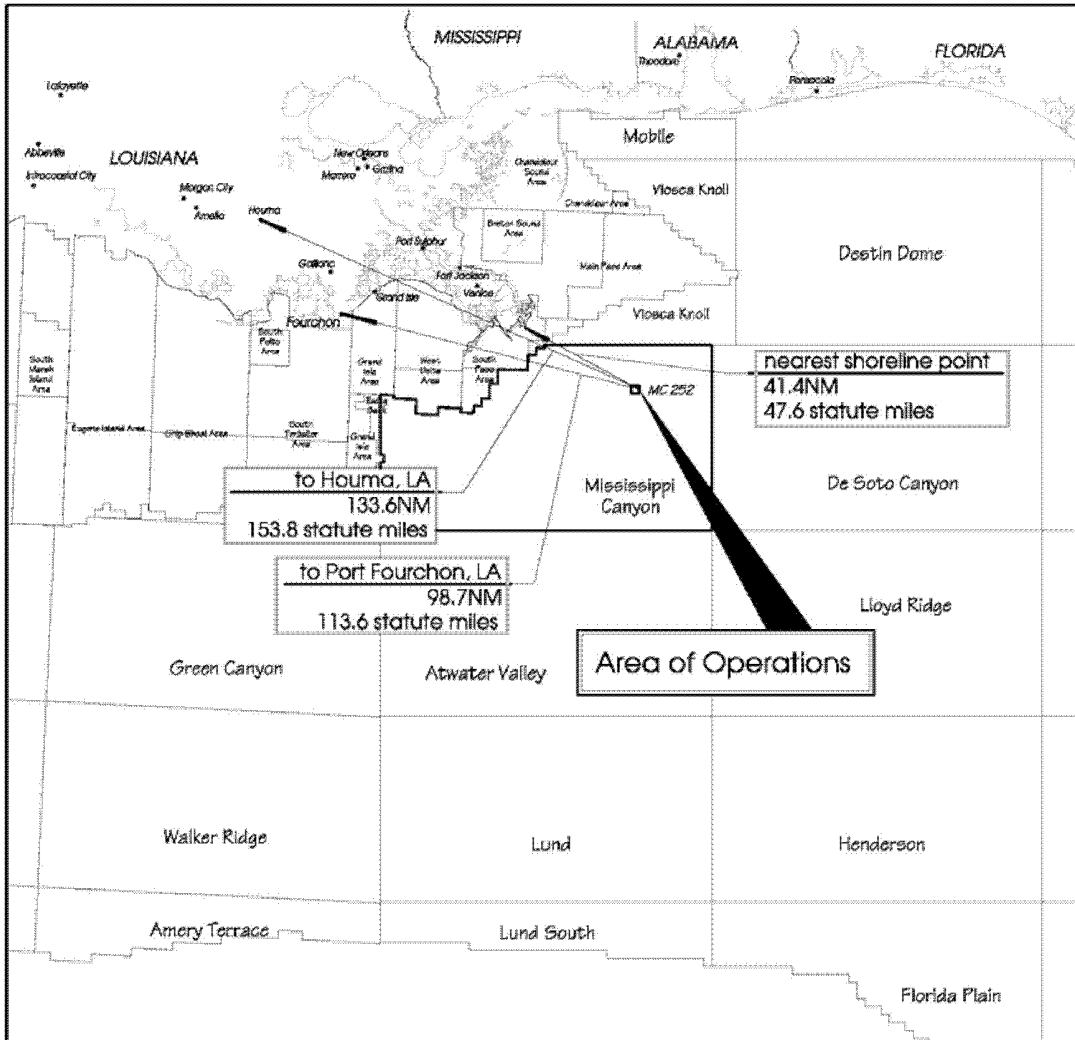

Projection: UTM Zone 16 North  
Datum: NAD27  
Distance Units: US Survey Feet

### "VICINITY CHART"



Sheet 1 of 2

	<b>BP EXPLORATION AND PRODUCTION</b>	Scale 1" = 50 miles
	Proposed Well Location OCS-G32306 MC 252, No. 1 ST00BP00	Date: 8May2009
	Mississippi Canyon Area (OPD# NH16-10) Block 252 Offshore Federal - Louisiana	
	Plot prepared by: Brian D. Autio, HPLS 1165 BP GoM SPU	

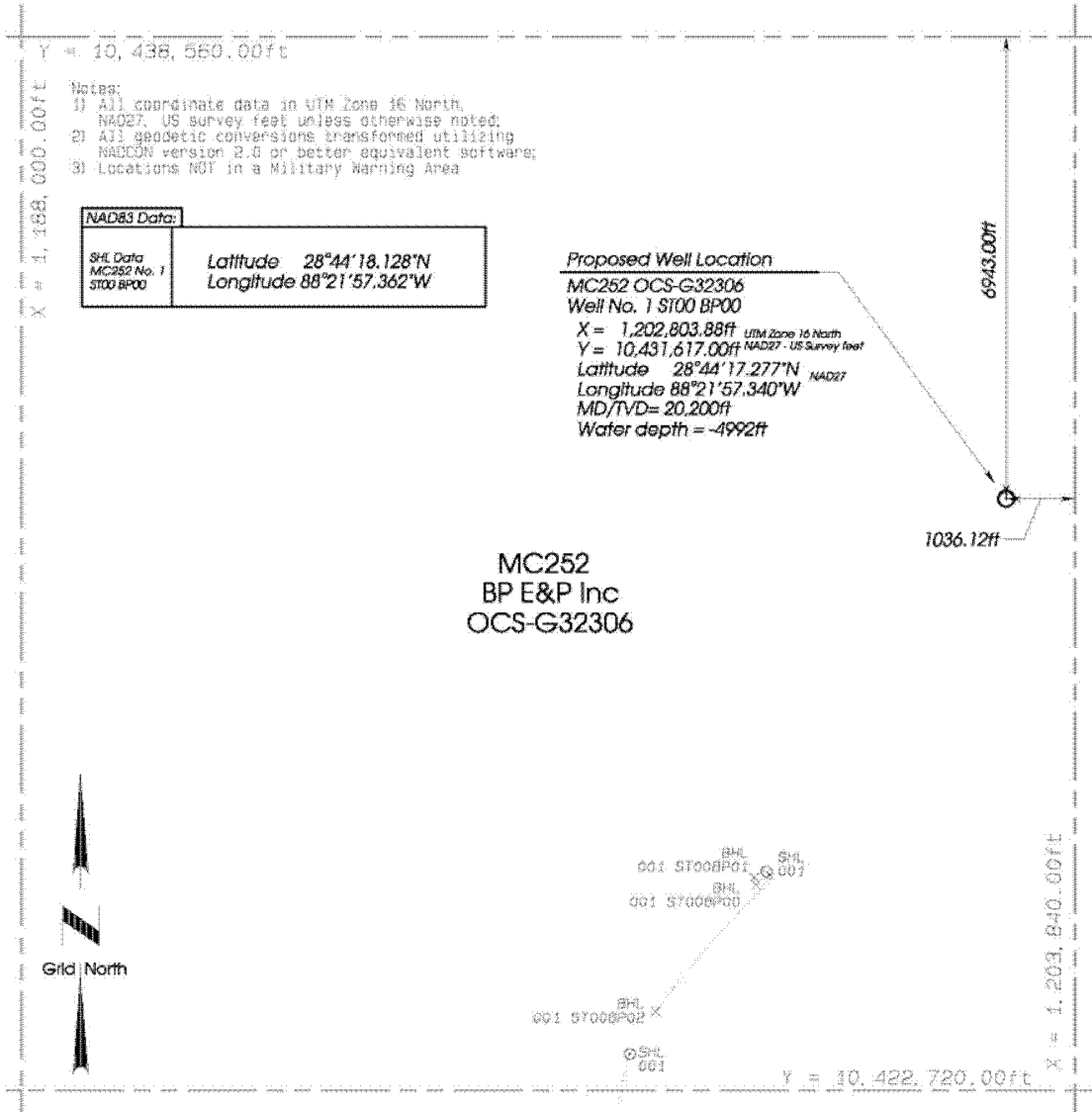
### 1.6 Location Plat

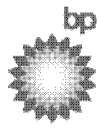

<p><b>Digital Copy</b> Signed &amp; sealed original on file</p> <p>Brian D. Autio      Date: 8 May 2009</p> <p>Registered Professional Land Surveyor State of Louisiana Registration Number 4818 Employee of bp America, Inc (281) 366-4452</p>	<p>I, Brian D. Autio, hereby certify that the proposed surface location of BP EXPL &amp; PROD. OCS-G32306 MC 252 No. 1 ST00BP00 is as follows: Location: 1,036.12 ft. from the East Line and 6,943.00 ft. from the North Line of Mississippi Canyon Block 252.</p>
<b>"Confidential Information"</b>	
Sheet 2 of 2	
	<b>BP EXPLORATION AND PRODUCTION</b> <b>Proposed Well Location OCS-G32306 MC 252 No. 1 ST00BP00</b> Mississippi Canyon Area (CPD# NH16-10) Block 252      Offshore Federal - Louisiana <small>Plat prepared by: Brian D. Autio, BPLS BP 1165 CoM SP1</small>
	Scale 1" = 2000 ft Date: 8 May 2009

	<b>GoM Exploration Wells</b> <b>MC 252 #1 – Macondo Prospect</b> <b>Well Information</b>	
---	--	---

## 1.7 Drilling Summary

### Prospect Overview

Macondo is a moderate depth Miocene prospect in the Mississippi Canyon area. The prospect is located entirely outside of any salt body. It is located approximately 24 miles north of BP's Isabela discovery which was drilled in MC 562 during 2006. The primary target for the Macondo prospect is the M56, which was the same as Isabela. The target depth for Macondo is approximately 18,400'. The well will be drilled to a TD of 19,650' to test the older Miocene section below the targeted M56. Seismic data quality over this prospect is very good since there is no salt involved. The well will be drilled as a vertical hole from the "A" location as permitted in the approved Exploration Plan for MC 252.

### Drilling Plan Summary



The Macondo well will be drilled with the Transocean "Marianas" moored Semi-Submersible rig in Mississippi Canyon Block 252 at a proposed surface location of 6,943' FNL and 1,036' FEL, in a water depth of 4,992 ft.

A structural string of 36" x 1-1/2" wall will be jetted (drilled) into position at approximately 280' below the mud line (~10' stick up). After completion of the jetting operations and appropriate waiting time, the running tool will be released and a 26" x 32-1/2" hole will be drilled riserless with seawater and viscous sweeps to an expected total depth of 6,275' md/tvd. There is a low potential for shallow water flow within this section. "Pump & dump" method will remain a contingency in the event any abnormally pressured sands are encountered.

At section TD, an 11.5 ppg pad mud will be spotted and the well will be monitored for flow prior to pulling out of the hole. Once out of the hole, 28" casing will be run to TD and cemented to the mud line with Halliburton foamed Class H lead and tail. The inner string will be pulled out of the hole only after confirmation is made of no flow and no detectable wellhead subsidence.

A 26" hole will be drilled with seawater and viscous sweeps to an expected total depth of 8,000' md/tvd. There is a low potential for shallow flow within this section. "Pump & dump" method will remain a contingency in the event any abnormally pressured sands are encountered. At section TD, 11.5 ppg pad mud will be spotted in open hole while leaving 16.0 ppg mud in the rat hole. Once a static wellbore is verified, the 22", 1.0" wall casing will be run to TD along with the Dril-Quip 18-3/4" high pressure wellhead and 1.25" wall extension joints. After a successful cement job with Halliburton's foamed Class H lead and tail, the wellhead will be pre-loaded to 1,500,000 lbs. The running tool and inner string will be pulled and operations to run BOP and riser will commence.

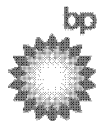

	<b>GoM Exploration Wells</b> <b>MC 252 #1 – Macondo Prospect</b> <b>Well Information</b>	
---	--	---

Once the BOP and riser are successfully installed and tested (per APD), the 22" casing and B/S rams will be tested per the APD. The well will be displaced to Baroid's 10.0 ppg synthetic oil base mud while drilling out the float equipment. A Leak-off Test (LOT) will be performed after drilling out. The estimated fracture gradient is ~11.1 ppg EMW. This setting depth should give sufficient fracture gradient to achieve 18" casing point at 9,900' md/tvd.

An 18-1/8" x 22" hole will be drilled with SOBM to a depth of 9900' md/tvd. At section TD, a 16.0 -16.5 ppg pad mud will be spotted in the rathole prior to POOH for 18" liner. The 18" liner will be run and cemented in place with Halliburton Class H lead and tail slurries. A Leak-off Test (LOT) will be performed after drilling out. The estimated fracture gradient is ~ 12.3 ppg EMW. This setting depth should give sufficient fracture gradient to achieve the 16" casing point at 12,500' md/tvd.

A 16-1/2" x 20" hole will be drilled with SOBM to 12,500' md/tvd. There is a very low chance of depleted sands in this interval and the standard 7/7/7 exploration formula will be applied with a preventive high concentration LCM pill ready if the depleted sand is encountered. A detailed plan will be in place to deal with the depleted plans if encountered and will be supplied to the rig separately prior to drilling this hole section. At section TD, a 16.0 - 16.5 ppg pad mud will be spotted in the rathole prior to POOH for 16" casing. After POOH, the 16" casing will be run and cemented in place with Halliburton Class H lead and tail slurries. A Leak-off Test (LOT) will be performed after drilling out. The estimated fracture gradient is ~13.6 ppg EMW. This setting depth should give sufficient fracture gradient to achieve the 13-5/8" casing point at 15,300' md/tvd.

A 14-3/4" x 16-1/2" hole will be drilled with SOBM to 15,300' md/tvd. At section TD, the rathole will be filled with 16.0 - 16.5 ppg pad mud prior to POOH for 13-5/8" liner. After POOH, the 13-5/8" liner will be run and cemented in place with Halliburton Class H lead and tail slurries. A Leak-off Test (LOT) will be performed after drilling out. The estimated fracture gradient is ~14.7 ppg EMW. This setting depth should give sufficient fracture gradient to achieve drilling to the TD of 20,200' md/tvd.

A 12-1/4" hole will be drilled to 19,650' md/tvd. The need for wireline evaluation of this interval will be determined by real time LWD data. A decision on the way forward will be made following evaluation of the open hole interval. The well will have either production casing run if exploration is successful, if not it will either P&A'd or temporarily abandoned. Once the final evaluation program is complete, a decision will be made as to whether to sidetrack, run production casing string, TA, or PA the well.

**1.8 Wellbore Schematic**

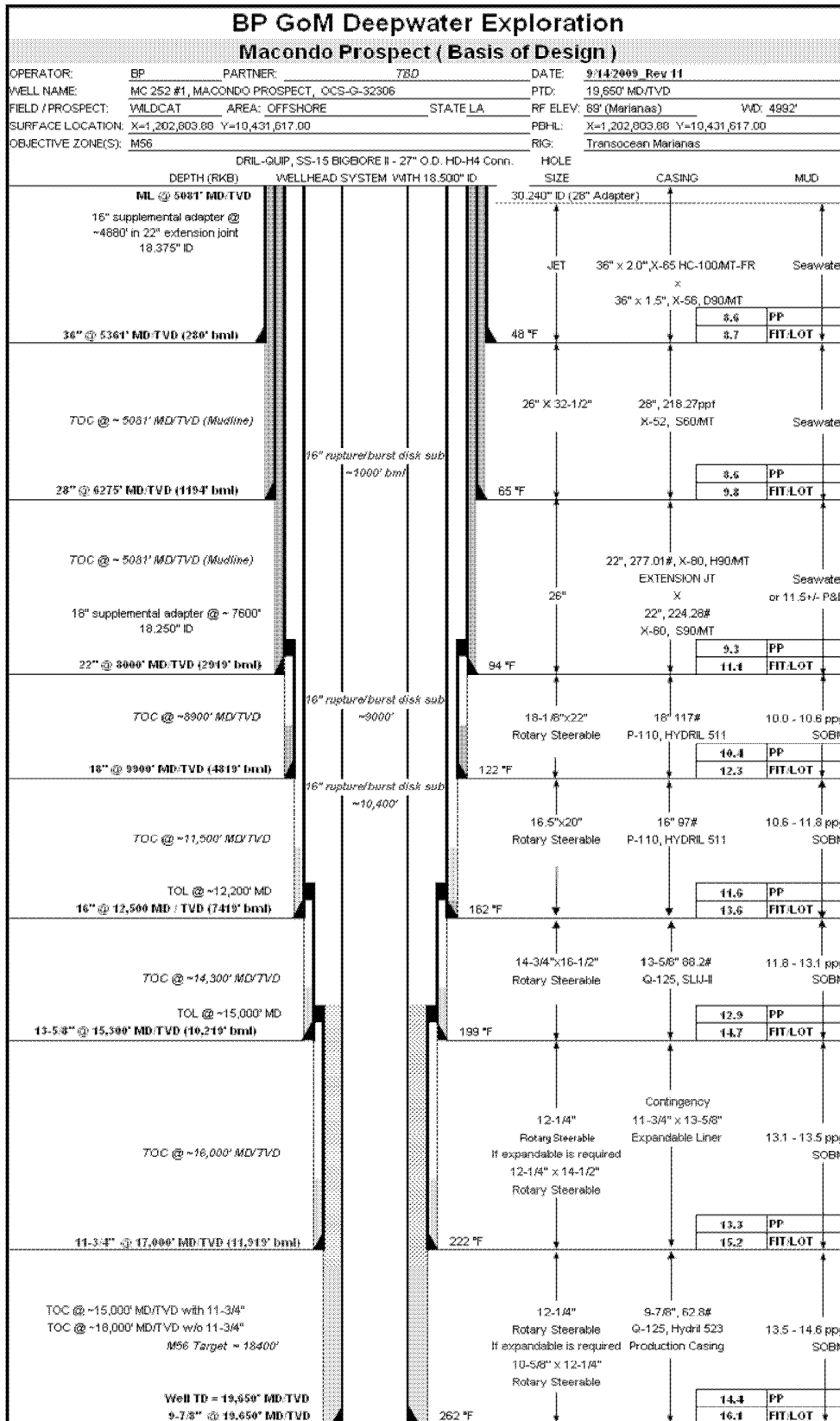

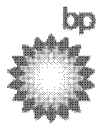

# GoM Exploration Wells

## MC 252 #1 – Macondo Prospect

### Well Information



### 1.9 Days vs Depth Curve

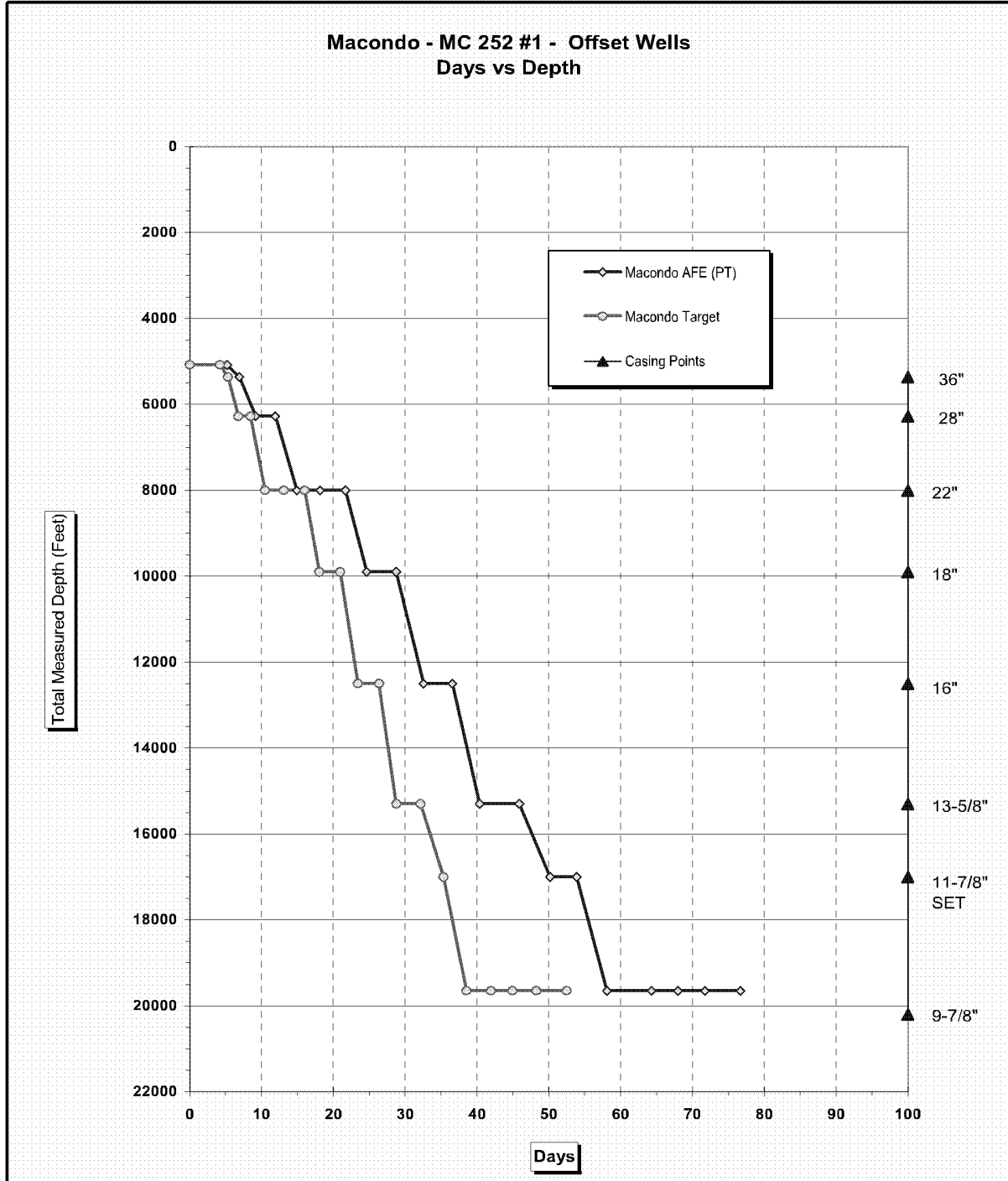

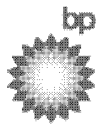

# GoM Exploration Wells

## MC 252 #1 – Macondo Prospect

### Well Information



### 1.10 Cost vs Depth Curve

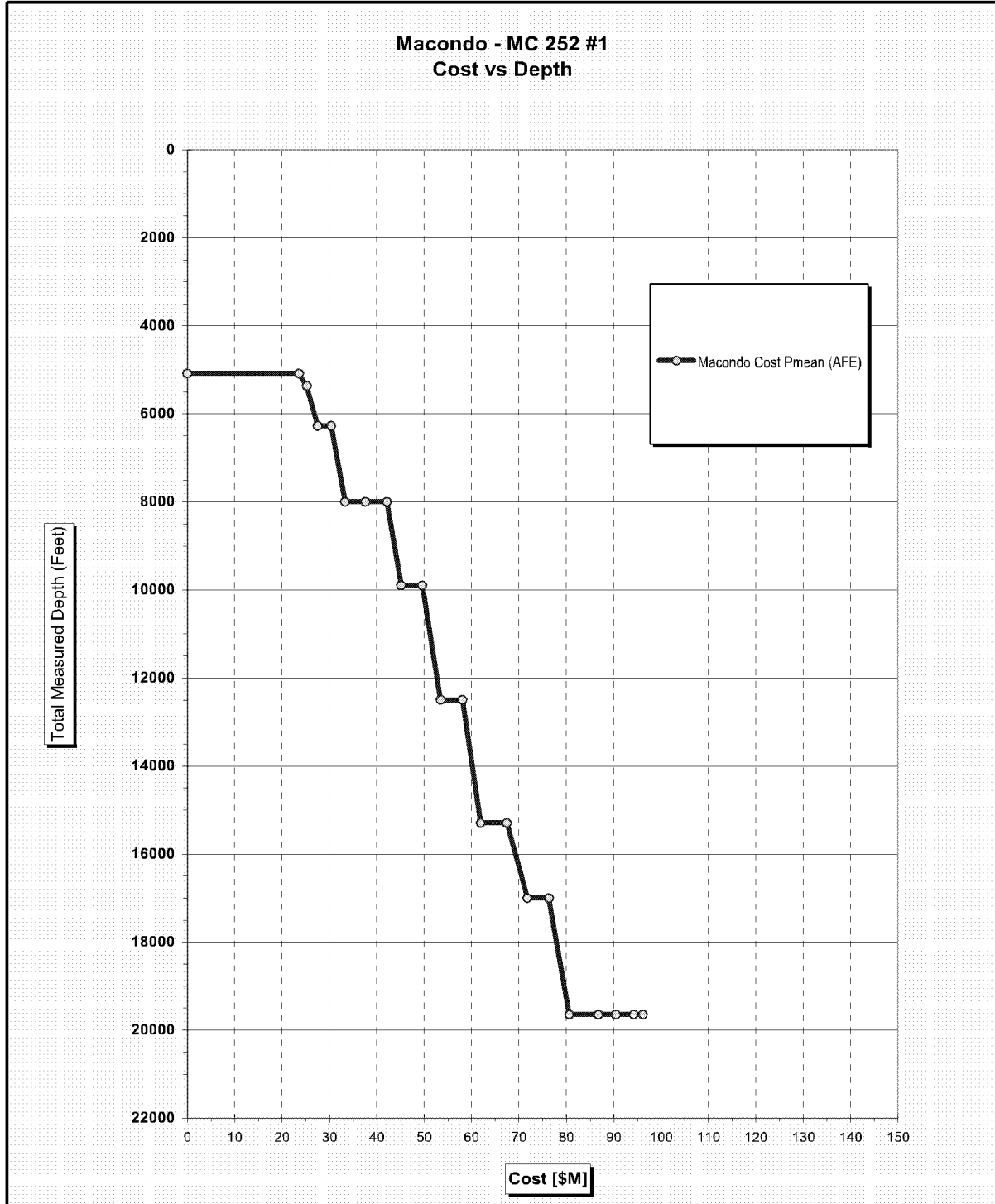

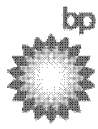

# GoM Exploration Wells

## MC 252 #1 – Macondo Prospect

### Well Information



## 1.11 Mud Program

### MC 252 #1 - Macondo Prospect

